

| | | |
|--|---|------------------------------------|
| CECW-EG Engineer Manual 1110-2-3800 | Department of the Army U.S. Army Corps of Engineers Washington, DC 20314-1000 | EM 1110-2-3800 1 March 1972 |
| | Engineering and Design SYSTEMATIC DRILLING AND BLASTING FOR SURFACE EXCAVATIONS | |
| | Distribution Restriction Statement Approved for public release; distribution is unlimited. | |

ENGINEERING AND DESIGN
Systematic Drilling and Blasting for
Surface Excavations

Table of Contents

| <u>Subject</u> | <u>Paragraph</u> | <u>Page</u> |
|---|------------------|-------------|
| Chapter 1. INTRODUCTION | | |
| Purpose ----- | 1-1 | 1-1 |
| Applicability ----- | 1-2 | 1-1 |
| References ----- | 1-3 | 1-1 |
| Duties of Government Construction | | |
| Personnel ----- | 1-4 | 1-2 |
| Construction Inspector ----- | 1-4a | 1-2 |
| Resident Geologist ----- | 1-4b | 1-2 |
| Specifications ----- | 1-5 | 1-2 |
| Working Relationships ----- | 1-6 | 1-3 |
| Geological Information ----- | 1-7 | 1-3 |
| Chapter 2. MECHANICS OF BLASTING | | |
| Explanation ----- | 2-1 | 2-1 |
| Partitioning of Energy ----- | 2-2 | 2-1 |
| Peak Pressure and Shock Wave ----- | 2-2a | 2-1 |
| Elastic (Seismic) Waves ----- | 2-2b | 2-1 |
| Air Waves ----- | 2-2c | 2-1 |
| Fragmentation Near an Explosion ----- | 2-3 | 2-2 |
| Zones of Deformation ----- | 2-3a | 2-2 |
| Spalling ----- | 2-3b | 2-3 |
| Combined Role of Expanding Gases ----- | 2-3c | 2-5 |
| Chapter 3. EXPLOSIVES AND THEIR PROPERTIES | | |
| Explanation ----- | 3-1 | 3-1 |
| Properties of Explosives ----- | 3-2 | 3-1 |
| Strength ----- | 3-2a | 3-1 |
| Detonation Velocity ----- | 3-2b | 3-4 |
| Density and Specific Gravity ----- | 3-2c | 3-5 |
| Detonation Pressure ----- | 3-2d | 3-5 |
| Water Resistance ----- | 3-2e | 3-7 |
| Fume Class ----- | 3-2f | 3-7 |
| Ingredients of Explosives ----- | 3-3 | 3-7 |

| Subject | Paragraph | Page |
|---|-----------|------|
| Dynamites ----- | 3-4 | 3-10 |
| Straight Nitroglycerin Dynamite----- | 3-4a | 3-10 |
| High-Density Ammonia (Extra) Dynamite----- | 3-4b | 3-10 |
| Low-Density Ammonia (Extra) Dynamite----- | 3-4c | 3-12 |
| Gelatins ----- | 3-5 | 3-13 |
| Blasting Gelatin ----- | 3-5a | 3-13 |
| Straight Gelatin ----- | 3-5b | 3-13 |
| Ammonia Gelatin ----- | 3-5c | 3-16 |
| Semigelatin ----- | 3-5d | 3-16 |
| Blasting Agents (Nitrocarbonitrates) --- | 3-6 | 3-16 |
| Dry Blasting Agents ----- | 3-6a | 3-17 |
| Slurries ----- | 3-6b | 3-18 |
| Other Explosives ----- | 3-7 | 3-20 |
| TNT ----- | 3-7a | 3-20 |
| PETN ----- | 3-7b | 3-20 |
| Pentolite ----- | 3-7c | 3-20 |
| RDX ----- | 3-7d | 3-20 |
| Composition B ----- | 3-7e | 3-20 |
| Permissible Explosives ----- | 3-7f | 3-20 |
| Black Powder ----- | 3-7g | 3-20 |
| Detonators and Primers----- | 3-8 | 3-21 |
| Blasting Caps ----- | 3-8a | 3-21 |
| Detonating Fuse ----- | 3-8b | 3-22 |
| Primers and Boosters ----- | 3-8c | 3-24 |
| Chapter 4. DRILLING | | |
| Introduction----- | 4-1 | 4-1 |
| Principles of Drilling ----- | 4-2 | 4-1 |
| Rotary Drills ----- | 4-3 | 4-4 |
| Roller Bits ----- | 4-3a | 4-4 |
| Diamond Bits ----- | 4-3b | 4-4 |
| Drag Bits ----- | 4-3c | 4-5 |
| Power Augers----- | 4-3d | 4-5 |
| Percussive Drills ----- | 4-4 | 4-8 |
| Rotary-Percussive Drills ----- | 4-5 | 4-11 |
| Chapter 5. BASIC SURFACE BLASTING TECHNIQUES | | |
| Introduction----- | 5-1 | 5-1 |
| Blasting Patterns----- | 5-2 | 5-1 |
| Hole Arrays ----- | 5-2a | 5-1 |
| Delay Patterns ----- | 5-2b | 5-3 |

| Subject | Paragraph | Page |
|--|-----------|------|
| Arrangement of Charge in Hole ----- | 5-2c | 5-3 |
| General Rock Removal ----- | 5-3 | 5-4 |
| Bench Blasting ----- | 5-3a | 5-4 |
| Spacing and Burden ----- | 5-3a(1) | 5-4 |
| Advantages of Inclined Blastholes ----- | 5-3a(2) | 5-5 |
| Lifters and Snake Holes ----- | 5-3a(3) | 5-6 |
| Varying the Hole Array to Fit Natural and Excavation Topography----- | 5-3a(4) | 5-8 |
| Charge Distribution----- | 5-3a(5) | 5-11 |
| Subdrilling----- | 5-3a(6) | 5-11 |
| Secondary Blasting ----- | 5-3a(7) | 5-12 |
| Coyote Blasting, Trenching, and Cratering ----- | 5-3b | 5-12 |
| Underwater Blasting ----- | 5-3c | 5-13 |
| Underwater Surface Shooting----- | 5-3c(1) | 5-14 |
| Underwater Blasting in Drill Holes ----- | 5-3c(2) | 5-14 |
| Excavation for Control of Rock Surfaces ----- | 5-4 | 5-14 |
| Presplitting----- | 5-4a | 5-15 |
| Design of the Presplitting Layout----- | 5-4a(1) | 5-15 |
| Relation to Main Blast ----- | 5-4a(2) | 5-19 |
| Presplitting Horizontal and Vertical Corners----- | 5-4a(3) | 5-20 |
| Horizontal Presplitting----- | 5-4a(4) | 5-20 |
| Smooth Blasting ----- | 5-4b | 5-21 |
| Line Drilling and Close Drilling----- | 5-4c | 5-21 |
| Precautions in Approaching Final Excavation Surfaces ----- | 5-4d | 5-23 |
| Blasting for Control of Rock Sizes----- | 5-5 | 5-23 |
| Riprap ----- | 5-5a | 5-24 |
| Aggregate ----- | 5-5b | 5-24 |
| Rock Fill for Dams ----- | 5-5c | 5-25 |
| Chapter 6. MODIFYING BLASTING TECHNIQUES TO FIT GEOLOGICAL CONDITIONS | | |
| Exploratory Study ----- | 6-1 | 6-1 |
| Rock Types ----- | 6-2 | 6-1 |
| Seismic Velocity ----- | 6-2a | 6-1 |
| Impedance ----- | 6-2b | 6-2 |
| Compressive and Tensile Strengths----- | 6-2c | 6-4 |
| Density and Porosity----- | 6-2d | 6-4 |
| Fractures and Fabric ----- | 6-3 | 6-4 |
| Joint Frequency ----- | 6-3a | 6-4 |
| Cushioning Joint Coatings ----- | 6-3b | 6-7 |

| Subject | Paragraph | Page |
|--|-----------|------|
| Orientation of Joints ----- | 6-3c | 6-7 |
| Orientation in Various Geological Settings ----- | 6-3c(1) | 6-8 |
| Adverse Orientations ----- | 6-3c(2) | 6-9 |
| Faults and Breccia ----- | 6-3d | 6-9 |
| Fabric ----- | 6-3e | 6-11 |
| Bedding and Stratification ----- | 6-4 | 6-12 |
| Alternating Rock Types ----- | 6-4a | 6-12 |
| Porous and Permeable Beds ----- | 6-4b | 6-13 |
| Weak Beds or Zones ----- | 6-4c | 6-13 |
| Dipping Strata ----- | 6-4d | 6-14 |
| Cavities ----- | 6-4e | 6-14 |
| Weathering ----- | 6-5 | 6-15 |
| Groundwater ----- | 6-6 | 6-16 |
| Chapter 7. DAMAGE PREDICTION AND CONTROL | | |
| Introduction ----- | 7-1 | 7-1 |
| Airblast ----- | 7-2 | 7-1 |
| Damage from Airblast ----- | 7-2a | 7-2 |
| Propagation of Airblasts ----- | 7-2b | 7-2 |
| Excessive Airblast Pressure ----- | 7-2c | 7-4 |
| Recording Equipment ----- | 7-2d | 7-4 |
| Ground Vibrations ----- | 7-3 | 7-5 |
| Damage from Ground Vibration ----- | 7-3a | 7-5 |
| Recording Equipment ----- | 7-3b | 7-11 |
| Propagation of Ground Vibrations ----- | 7-3c | 7-12 |
| Reducing Vibrations ----- | 7-3d | 7-15 |
| Calibration of Site Vibration Levels --- | 7-3e | 7-16 |
| Flyrock ----- | 7-4 | 7-17 |
| Chapter 8. DRILLING AND BLASTING IN ROCK EXCAVATION BY CONTRACT | | |
| General ----- | 8-1 | 8-1 |
| Customary Contract Approach ----- | 8-1a | 8-1 |
| Variation of Customary Approach ----- | 8-1b | 8-1 |
| Considerations in Preparation of Plans and Specifications ----- | 8-2 | 8-2 |
| Stated Principles of Plans and Specifications ----- | 8-2a | 8-2 |
| Pertinent General and Special Provisions ----- | 8-2b | 8-2 |
| Geologic Data ----- | 8-2c | 8-3 |
| Review Plans for Practicality of Excavation Outlines ----- | 8-2d | 8-3 |

| Subject | Paragraph | Page |
|--|-----------|------|
| Construction Inspection To Be | | |
| Expected ----- | 8-2e | 8-3 |
| Blast Records----- | 8-2f | 8-3 |
| Sequence of Operations----- | 8-2g | 8-4 |
| Specifying Methods—Obtaining Sound | | |
| Walls ----- | 8-2h | 8-4 |
| Obtaining Final Grade----- | 8-2i | 8-4 |
| Specifying and Prohibiting Certain | | |
| Practices ----- | 8-2j | 8-4 |
| Requiring Gradation Ranges in Blasted | | |
| Rock----- | 8-2k | 8-4 |
| Vibration and Damage Control ----- | 8-2l | 8-7 |
| Appendix A - References----- | | A-1 |
| Appendix B - Typical CE Blasting Specifications--- | | B-1 |
| Index ----- | | I-1 |

List of Illustrations

| Title | Fig. No. | Page |
|---|----------|------|
| Zones of fracturing and deformation around an explosion in rock ----- | 2-1 | 2-2 |
| Tensile fracture by reflection of a compressive strain pulse ----- | 2-2 | 2-4 |
| Common sizes of dynamite cartridges ----- | 3-1 | 3-2 |
| Nomograph for comparing weight strength and cartridge strength ----- | 3-2 | 3-3 |
| Some relative properties and ingredients of commercial explosives ----- | 3-3 | 3-4 |
| Nomograph for finding detonation pressure----- | 3-4 | 3-6 |
| Average confined velocity and specific gravity and calculated detonation pressure of explosives ----- | 3-5 | 3-8 |
| Application of blasting caps ----- | 3-6 | 3-21 |
| Safety fuse and cap----- | 3-7 | 3-23 |
| Millisecond delay connectors ----- | 3-8 | 3-24 |
| Types of failure induced by a drill bit ----- | 4-1 | 4-2 |

1 Mar 72

| Title | Fig. No. | Page |
|--|----------|------|
| Relation between quartz content and uniaxial strength of sedimentary rock ----- | 4-2 | 4-2 |
| Relation of compressive strength and bulk specific gravity for basalt ----- | 4-3 | 4-3 |
| Track-mounted rotary drill (9-in. bit) ----- | 4-4 | 4-5 |
| Roller bits used in quarrying rock of different hardness ----- | 4-5 | 4-6 |
| Small-diameter diamond bits (3 in. or smaller) ---- | 4-6 | 4-7 |
| Drag bits ----- | 4-7 | 4-7 |
| Typical surface jackhammer drill design ----- | 4-8 | 4-9 |
| Bits and steel assembly for surface hammer drills ----- | 4-9 | 4-10 |
| Bits for down-the-hole hammer drill ----- | 4-10 | 4-10 |
| Wagon drill ----- | 4-11 | 4-11 |
| Crawler drill capable of drilling holes from 1-3/4 to 3 in. in diameter ----- | 4-12 | 4-12 |
| Churn drill bit ----- | 4-13 | 4-13 |
| Rotary-percussive drill bit ----- | 4-14 | 4-14 |
| Basic blasthole arrays ----- | 5-1 | 5-1 |
| Variation of regular arrangement of production blastholes as necessitated by topography ----- | 5-2 | 5-2 |
| Single-hole arrays ----- | 5-3 | 5-2 |
| Some possible delay patterns ----- | 5-4 | 5-3 |
| Trapezoidal blasting pattern ----- | 5-5 | 5-5 |
| Shock-wave propagation through rock generated by detonation of toe charge ----- | 5-6 | 5-6 |
| Bench-slab movement during blast with vertical and inclined holes ----- | 5-7 | 5-7 |
| Typical placement of snake hole ----- | 5-8 | 5-7 |
| Varying the direction of throw by arrangement of delays ----- | 5-9 | 5-8 |
| Multiple-row round including a V-cut opening ----- | 5-10 | 5-9 |
| Large quarry blast pattern measuring 600 by 100 by 48 ft ----- | 5-11 | 5-9 |
| Delays, in milliseconds ----- | 5-12 | 5-10 |
| Distribution of inclined holes for a road cut in uneven topography. Regular hole array distorted to fit topography ----- | 5-13 | 5-10 |
| Charge distribution in bench blasting ----- | 5-14 | 5-12 |
| Plan of coyote layout with detonating cord ----- | 5-15 | 5-13 |
| Blasthole patterns for underwater blasting ----- | 5-16 | 5-14 |
| Presplit blasting in limestone for a powerhouse --- | 5-17 | 5-16 |
| Presplit fracture ----- | 5-18 | 5-17 |
| Section of typical presplit holes ready for firing --- | 5-19 | 5-18 |

| Title | Fig. No. | Page |
|--|----------|------|
| Relation of presplit to main pattern ----- | 5-20 | 5-20 |
| Use of guide holes in presplitting inside and out- side corners ----- | 5-21 | 5-21 |
| Typical arrangement of line drilling with respect to main blastholes ----- | 5-22 | 5-22 |
| Main charge delays----- | 5-23 | 5-24 |
| Plan of blasthole pattern for fragmentation of rock to produce aggregate ----- | 5-24 | 5-25 |
| Typical impedance calculation for granite----- | 6-1 | 6-2 |
| Empirical relation: blasthole spacing and diameter and powder factor for multiple-row blast pattern in rocks of different strengths----- | 6-2 | 6-5 |
| Sonic log travel time as a function of porosity for a suite of volcanic sedimentary rocks and lava --- | 6-3 | 6-6 |
| Adverse dip of joints into excavation ----- | 6-4 | 6-10 |
| Variation of shear strength with inclination to schistosity (y-z plane) in fine-grained gneiss ---- | 6-5 | 6-11 |
| Effect of dipping strata on stability of excavation -- | 6-6 | 6-14 |
| Propagation laws for airblast pressure from spherical charges for various scaled depths of burial and from quarry blasting rounds----- | 7-1 | 7-3 |
| Summary of damage criterion data for frame structure ----- | 7-2 | 7-6 |
| Summary of nondamaging data above recommended safe vibration level for frame structures ----- | 7-3 | 7-7 |
| Subjective response of the human body to vibratory motion----- | 7-4 | 7-9 |
| Particle-velocity data versus distance for one site ----- | 7-5 | 7-14 |
| Maximum observed ranges of natural missiles for buried explosions in basalt ----- | 7-6 | 7-18 |
| Example of one form of blasting log kept by contractor ----- | 8-1 | 8-5 |
| Record of blasting required by one CE District---- | 8-2 | 8-6 |



EM 1110-2-3800
1 Mar 72

CHAPTER 1. INTRODUCTION

1-1. Purpose. This manual describes reliable or preferred procedures or concepts of drilling and blasting conducted during rock excavation, in order to aid design and construction personnel in related matters (para 1-4). Drilling and blasting methods described herein are not to be regarded as official Corps of Engineers (CE) policy, but they should be of assistance to CE personnel in establishing policy. The manual is designed principally for the use of geologists and engineers who are given responsibilities in drilling and blasting projects. Such responsibilities may come either in the design or in the construction phase.

1-2. Applicability. The provisions of this manual are applicable to CE Divisions and Districts concerned with Civil Works design and construction.

1-3. References.

a. Department of the Army publications on related subjects are listed below:

- | | |
|--------------------|--|
| (1) ER 1110-2-1200 | Plans and Specifications |
| (2) EM 385-1-1 | General Safety Requirements |
| (3) EM 1110-1-1801 | Geological Investigations |
| (4) EM 1110-1-1806 | Presenting Subsurface Information in Contract Plans and Specifications |
| (5) EP 415-1-261 | Construction Inspectors Guide |
| (6) TM 5-332 | Pits and Quarries |

b. Strict adherence to safety precautions in blasting is of utmost importance. Publications specifically on safety in blasting include:

- | | |
|---|---|
| Handbook of Electric Blasting | Atlas Chemical Industries, Inc., Explosives Division |
| Manufacture, Storage, Transportation and Use of Explosives and Blasting Agents, 1968 Rev Ed. | National Fire Protection Assoc. |

The following are obtainable from Institute of Makers of Explosives,
420 Lexington Ave., New York, N. Y. 10017

Standard Storage Magazines, 1957, Pamphlet 1

Safety in the Handling and Use of Explosives, 1960, Pamphlet 17

How to Destroy Explosives, Pamphlet 21

Rules for Storing, Transporting, and Shipping Explosives,
Publication 5

American Table of Distances for Storage of Explosives, 1964,
Pamphlet 2

Do's and Don'ts, 1964

Radio Frequency Energy, 1968, Rev Ed., Pamphlet 20

c. A series of CE engineer manuals on rock excavation is anticipated for the future. The drilling and blasting manual for surface excavations is the first of this series. Selected references that describe drilling and blasting procedures and results as well as specific application in construction are cited herein by superscript numbers; these numbers correspond to those in Appendix A, References.

1-4. Duties of Government Construction Personnel. The Resident Engineer usually bears ultimate responsibility for major decisions but relies on his inspectors and resident geologist for advice.

a. Construction Inspector. The construction inspector will determine that blasting methods used by the contractor are in compliance with the requirements of the plans and specifications and also that the work complies with the blasting program and methods submitted by the contractor to the Contracting Officer. Significant deviations will be reported to the Resident Engineer for a decision. The inspector will report on a Government form information concerning the program and blasting method, as discussed in Chapter 8 of this manual. The inspector also should report daily observations and progress of the job to the resident geologist.

b. Resident Geologist. The resident geologist should be intimately familiar with the rocks and their properties so that he, in turn, can assist the Resident Engineer regarding blasting progress and any problems that arise.

1-5. Specifications.

a. The principal intent of the specifications is to inform the

contractor what the work is to be and the conditions he will encounter. At present, no "Guide Specifications for Civil Works Construction" on drilling and blasting exist. Certain provisions are included in specifications of CE Districts to ensure desired results. Chapter 5 of this manual includes information on basic blasting techniques that may be helpful in preparation of these specifications, and a few sample specifications are presented in Appendix B.

b. The contractor can be closely restricted by specifications that require procedures assuring no damage to the excavation or adjacent structures. An advantage of this type of specification is that it gives a legal basis for the Contracting Officer to supervise the contractor's compliance. Other specifications may allow the contractor relative freedom to choose his procedure as long as the final excavation is satisfactory. Incentive can be included in such specifications; e.g., the contractor may find it to his advantage or disadvantage in concrete payment according to whether his final rock surface (after scaling) falls within the rock excavation tolerances.

1-6. Working Relationships. A cooperative spirit should be maintained among CE personnel, drillers, and blasting crew if the best results are to be obtained. Although the inspector monitors the drilling and blasting operations, he does not take over the role of foreman for the contractor, i.e., should refrain from giving orders directly to workmen. A thorough knowledge of drilling and blasting techniques is the best assurance of a satisfactory job. Chapters 2 through 5 of this manual are intended to help in this regard.

1-7. Geological Information. The geology of the project can be a major factor in a successful blasting job. The bidding documents should reflect the geological conditions and establish procedures compatible with the results desired. Design memoranda and technical letters covering the geology of the project site should be made available to and be carefully reviewed by the field forces. For details of the effects of geological conditions on blasting, see Chapter 6.

EM 1110-2-3800
1 Mar 72

CHAPTER 2. MECHANICS OF BLASTING

2-1. Explanation. The mechanics of blasting are treated in this chapter in a simplified manner to point out basic principles and conditions. References 1 and 2 were used as the sources of much of the information. Supplementary information on rock damage from blasting is found in Chapter 7. The word "explosive" as used herein is defined as a chemical compound or a mixture of compounds that reacts to liberate heat or mechanical energy by decomposing rapidly into other compounds, mostly gases.

2-2. Partitioning of Energy. Although complicated, the general mechanics of blasting are now at least partially understood. Three main stages of blasting are pressure buildup, wave transmission, and airblast.

a. Peak Pressure and Shock Wave. Explosion gases occupy a much greater volume at ordinary confining pressures than the original charge and are capable of building up transient peak pressures of 10^5 atmospheres (atm) or more in the vicinity of the charge. A resulting shock wave generated within a few milliseconds (msec) following detonation propagates away from the explosive charge. Even the strongest rocks are shattered in the immediate vicinity.

b. Elastic (Seismic) Waves. Work is performed in crushing rock surrounding the charge, and consequently the initial shock wave begins to decay in intensity after leaving the point of detonation. At a relatively short distance the compressive pulse is reduced to a level of intensity below the compressive strength of the rock. From this point on rock crushing stops, but other pressure or primary (P) and shear (S) waves continue through the rock mass. The velocity of the P-wave varies mainly according to the elastic properties of the rock. In weak rock, it will travel approximately 5,000 to 10,000 feet per second (fps) and in strong rock with little jointing, it will travel as fast as 20,000 fps. P- and S-waves perform work by moving the rock particles longitudinally and transversely. For this reason, the waves will attenuate until they eventually die out or until a free face is encountered. The distance of travel of these waves is measured in hundreds and thousands of feet in construction blasting. These waves are of considerable importance in regard to damage and vibration control (Chapter 7).

c. Air Waves. A portion of the energy that reaches the free face as a P-wave may be transferred to the air in the form of an air wave (para 7-2).

2-3. Fragmentation Near an Explosion.

a. Zones of Deformation.

(1) Fig. 2-1 shows fracturing and deformation zones around the explosion. This illustration represents a spherically symmetric picture

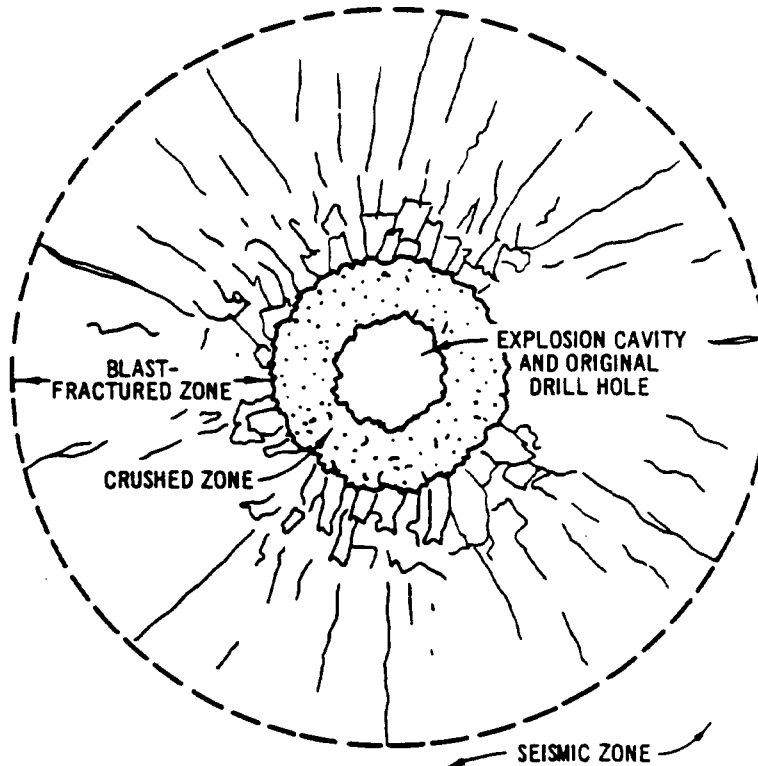

Fig. 2-1. Zones of fracturing and deformation around an explosion in rock

for a spherical charge or a section perpendicular to the axis of a cylindrical charge. The rock medium assumed for this illustration is essentially infinite in extent so that the effects of free boundaries are not included.

(2) Four major zones can develop. The first is the explosion cavity (essentially the original charge cavity) where the process is hydrodynamic. The second and third zones are the crushed and blast-fractured zones, respectively, where the shock pressure is rapidly reduced as a result of plastic flow, crushing, and cracking. The fourth zone is the seismic zone, where the stress is below the elastic limit and no fragmentation occurs, except near free boundaries as discussed below.

The crushed zone is minimized or eliminated in well-designed pre-splitting (para 5-4a).

(3) Crushing and fracturing are functions of the explosive type, charge loading, and the rock parameters. The size of the crushed zone is usually larger in rocks of lower compressive strength. Use of explosives with low detonation pressures or decoupled charges (isolated from rock by air space) in competent rock may reduce crushed zones and control the extent of the blast fracturing. The crushed zone typically extends to about twice the charge radius.³ The radius of the blast-fractured zone is typically about six times the radius of the crushed zone,³ or about three to four times the radius of the crushed zone adjacent to a very large point charge.⁴ The spacing between fractures increases outward. Radial fractures develop from hoop stresses at the front of the divergent stress wave.² A second and equally important type of fracturing in the blast-fractured zone is spalling as discussed below.

b. Spalling.

(1) Natural joints and free faces promote spalling fragmentation. First there are air-rock interfaces, that is, the excavation surface or free face. Second there are a multitude of open fissures, bedding planes, etc., that constitute internal free faces.

(2) Spalling is caused by tensile stress resulting from interference between the tail portion of an incident compressional wave and the front of the same wave which has been transformed on reflection at the free surface into a tensional wave. Rocks being strong in compression but weak in tension⁵ (Table 2-1) are particularly prone to spalling. They are able to transmit very high compressive stresses, but when these are transformed on reflection into tensile stresses, the rocks may fracture or spall.

(3) The higher the ratio of compressive to tensile strengths, the more extensive the spalling becomes. The ratio is sometimes known as the blasting coefficient (para 6-2c). The harder and more competent rocks are more susceptible to spalling.

(4) As shown in Fig. 2-2, the spall fracture develops parallel to the reflecting surface. These new cracks, in turn, serve as reflecting surfaces converting following compressional waves to destructive tensional waves. Thus, other parallel spalls form until attenuation subdues the tensional waves to below the destructive level (tensile strength of rock), or until the spalling has migrated back to the explosion cavity.

Table 2-1. Unconfined Compressive and Tensile Strengths of Rocks and Blasting Coefficients⁽¹⁾

| Rock Type | Unconfined Compressive Strength psi | Unconfined Tensile Strength psi | Blasting Coefficient |
|-------------------|--|------------------------------------|----------------------|
| Quartzite | 31,650 | 2,510 | 13 |
| Quartzite | 22,250 | 2,550 | 9 |
| Quartzite | 43,700 | 2,950 | 15 |
| Argillite | 31,400 | 2,620 | 12 |
| Diabase | 53,300 | 3,550 | 15 |
| Basalt | 9,800 | 730 | 13 |
| Basalt | 26,500 | 1,990 | 13 |
| Basalt | 40,800 | 4,020 | 10 |
| Gabbro | 29,600 | 2,150 | 14 |
| Gabbro | 25,050 | 1,810 | 14 |
| Granite | 24,350 | 1,780 | 14 |
| Granite | 22,000 | 1,300 | 17 |
| Granite | 28,950 | 1,850 | 16 |
| Marble | 18,150 | 1,010 | 18 |
| Limestone | 14,200 | 820 | 17 |
| Limestone | 17,800 | 910 | 20 |
| Dolomite | 13,800 | 600 | 23 |
| Hornblende schist | 29,600 | 1,080 | 27 |

(1) The strengths and blasting coefficients are not necessarily representative in general of the particular rock type.

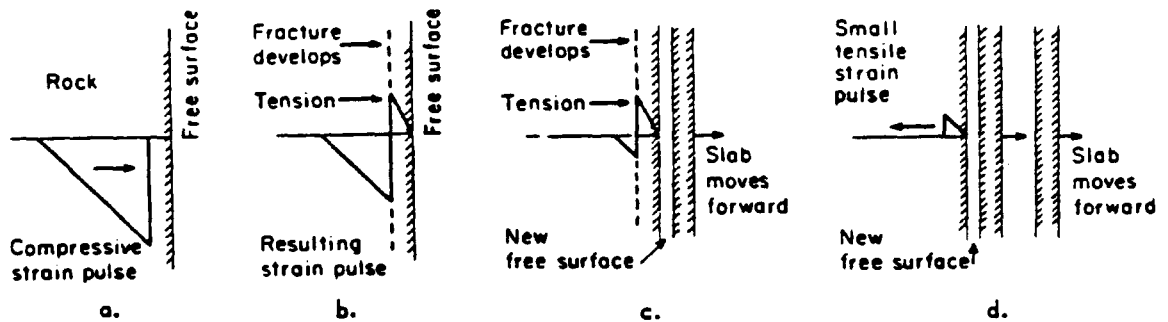

(Courtesy of The American Institute of Mining, Metallurgical, and Petroleum Engineers, Inc.)

Fig. 2-2. Tensile fracture by reflection of a compressive strain pulse (after Atchison¹)

c. Combined Role of Expanding Gases. The combined effects of rock fracturing by compressional and tensional waves are greatly augmented by hot expanding gases that work their way along fractures, churning pieces together and moving large blocks en masse. Fragmentation results in part from collision of pieces. The shock wave is responsible for only a part of the breakage. The whole process is a complex interaction of several processes.

EM 1110-2-3800
1 Mar 72



CHAPTER 3. EXPLOSIVES AND THEIR PROPERTIES⁽¹⁾

3-1. Explanation. A chemical explosive is a compound or a mixture of compounds which, when subjected to heat, impact, friction, or shock, undergoes very rapid, self-propagating, heat-producing decomposition. This decomposition produces gases that exert tremendous pressures as they expand at the high temperature of the reaction. The work done by an explosive depends primarily on the amount of heat given off during the explosion. The term detonation indicates that the reaction is moving through the explosive faster than the speed of sound in the unreacted explosive; whereas, deflagration indicates a slower reaction (rapid burning). A high explosive will detonate; a low explosive will deflagrate. All commercial explosives except black powder are high explosives.

3-2. Properties of Explosives. Important properties of explosives are weight strength, cartridge strength, detonation velocity, density, detonation pressure, water resistance, and fume class. For each explosive these properties will vary with the manufacturer and his methods of measurement.

a. Strength.

(1) Strength has been traditionally used to describe various grades of explosives, although it is not a true measure of ability to perform work and is therefore misleading. Because the term is so common in the industry, however, inspectors and other CE personnel should have some knowledge of the basis of strength ratings.

(2) The two common ratings are "weight strength," which compares explosives on a weight basis, and "cartridge strength" (bulk strength), which compares explosives on a volume basis. Strengths are commonly expressed as a percentage, with straight nitroglycerin dynamite taken as the standard for both weight and cartridge strength. For example, 1 lb of extra dynamite with a 40 percent weight strength, 1 lb of ammonia gelatin with a 40 percent weight strength, and 1 lb of straight dynamite with a 40 percent weight strength are considered equivalent. One 1-1/4- by 8-in. cartridge of extra dynamite with a 30 percent cartridge strength, one 1-1/4- by 8-in. cartridge of semi-gelatin with a 30 percent cartridge strength, and one 1-1/4- by 8-in. cartridge of straight dynamite with a 30 percent cartridge strength are equivalent. Fig. 3-1 illustrates a variety of dynamite cartridge sizes.

(1) This section is largely a condensation of U. S. Bureau of Mines Information Circular 8405 by R. A. Dick.⁶

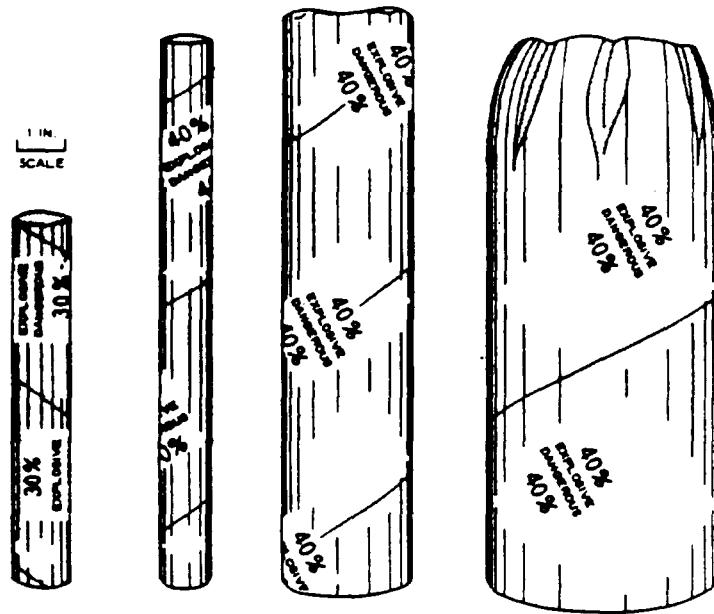

Fig. 3-1. Common sizes of dynamite cartridges

(3) The term strength was first applied when dynamite was a mixture of nitroglycerin and inert filler, such as kieselguhr (diatomite). Then 60 percent dynamite contained 60 percent nitroglycerin by weight and was three times as strong as a 20 percent dynamite. Straight dynamites today contain such active ingredients as sodium nitrate and carbonaceous material in place of inert filler. Consequently, a 60 percent straight dynamite, which contains 60 percent nitroglycerin by weight is only about 1.5 times as strong, because of the energy supplied by the additional active ingredients in the 20 percent grade. Furthermore, 60 percent weight strength straight dynamite and 60 percent weight strength extra dynamite will produce different results due to a difference in detonation velocity.

(4) Normally the cartridge count, i.e. the number of cartridges in a 50-lb box, and one of the strength ratings can be obtained for an explosive. A nomograph relating the two strength ratings is given in Fig. 3-2. The cartridge count is roughly 140 divided by the specific gravity. If a line is drawn through the cartridge count and the given strength rating, the unknown strength can be read where this line intersects the scale of the unknown strength.

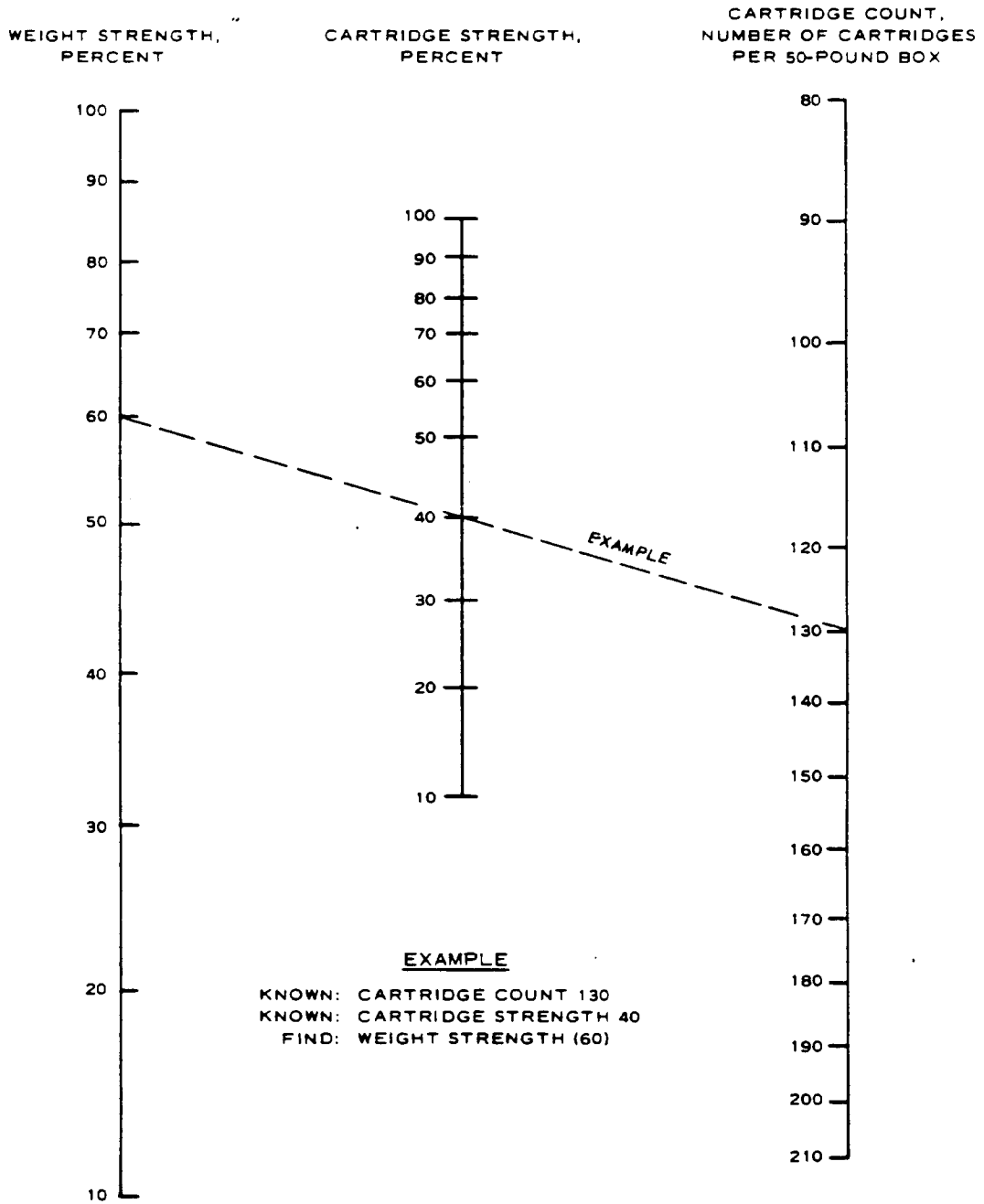

Fig. 3-2. Nomograph for comparing weight strength and cartridge strength⁶

(5) Usually dynamites are rated on weight strength and gelatins on cartridge strength. Commonly only a trade name or a coded designation is given, and the strength as well as the explosive type usually must be obtained from the manufacturer.

(6) These examples show that strength is not a good basis for rating explosives. Detonation pressure is a better indicator of an explosive's ability to perform work (see d below).

b. Detonation Velocity.

(1) The most important single property in rating an explosive is detonation velocity, which may be expressed for either confined or unconfined conditions. It is the speed at which the detonation wave travels through the explosive. Since explosives in boreholes are confined to some degree, the confined value is the more significant. Most manufacturers, however, measure the detonation velocity in an unconfined column of explosive 1-1/4 in. in diameter. The detonation velocity of an explosive is dependent on the density, ingredients (Fig. 3-3), particle size, charge diameter, and degree of confinement. Decreased particle size, increased charge diameter, and increased confinement all tend to increase the detonation velocity. Unconfined velocities are generally 70 to 80 percent of confined velocities.

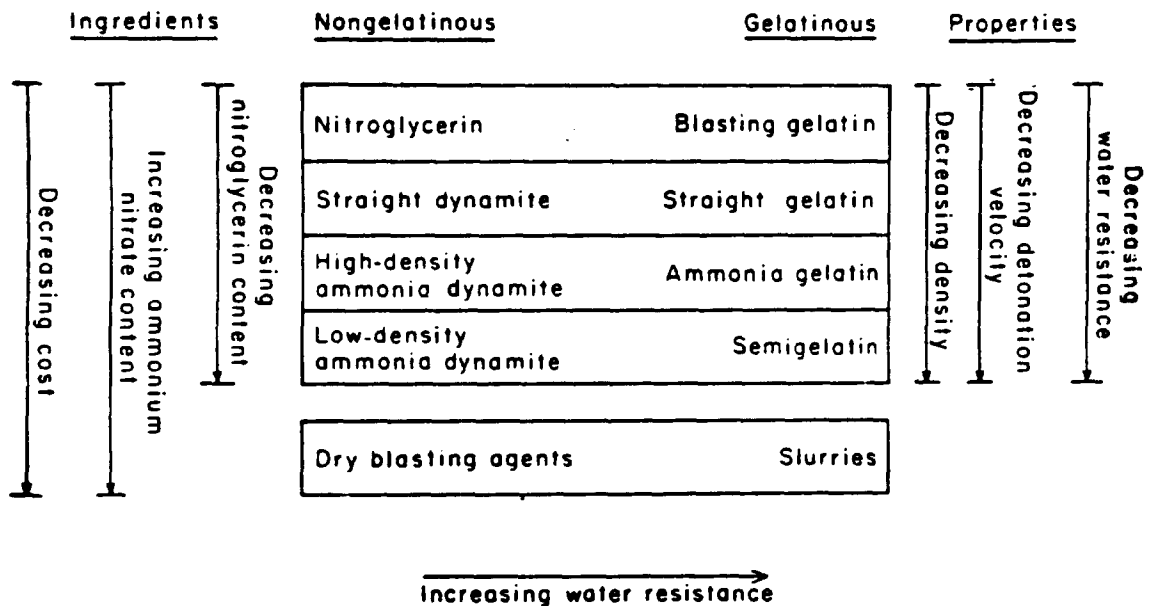

Fig. 3-3. Some relative properties and ingredients of commercial explosives⁶

1 Mar 72

(2) The confined detonation velocity of commercial explosives varies from 4,000 to 25,000 fps. With cartridge explosives the confined velocity is seldom attained. Some explosives and blasting agents (see para 3-6) are sensitive to diameter changes. As diameter is reduced, the velocity is reduced until at some critical diameter, propagation is no longer assured and misfires are likely.

c. Density and Specific Gravity. Densities of explosives are usually indicated in terms of specific gravity.

(1) The specific gravity of commercial explosives ranges from 0.6 to 1.7 with corresponding cartridge counts of 232 to 83. For bulk explosives, the pounds of explosive per foot of charge length in a given size borehole is often referred to as the charge concentration (or loading density).

(2) Denser explosives usually give higher detonation velocities and pressures. A dense explosive may be desirable for difficult blasting conditions or where fine fragmentation is required. Low-density explosives will suffice in easily fragmented or closely jointed rocks and are preferred for quarrying coarse material.

(3) The density of an explosive is important in wet conditions. An explosive with a specific gravity of less than 1.0 or a cartridge count greater than 140 will not sink in water.

d. Detonation Pressure.

(1) Detonation pressure, a function of the detonation velocity and density, is a measure of the pressure in the detonation wave. Since detonation pressure is not usually mentioned as a property of an explosive, it is not usually considered in the choice of an explosive. However, the amplitude of the stress pulse from an explosion in rock is related to the detonation pressure. The reflection of this stress pulse at a free face is an important mechanism in spalling. The relationship of detonation velocity and density to detonation pressure is somewhat complex but the following equation approximates it.⁷

$$P = 4.18 \times 10^{-7} \left(\frac{DC^2}{1 + 0.80D} \right)$$

where

P = detonation pressure, kilobars (1 kbar = 14,504 psi)

EM 1110-2-3800
1 Mar 72

D = specific gravity
C = detonation velocity, fps

The nomograph in Fig. 3-4 can be used to find the detonation pressure of an explosive when the detonation velocity and specific gravity are known. The detonation pressure depends more on detonation velocity (see equation on page 3-5) than on specific gravity. A high detonation pressure is preferable for fragmenting hard, dense rock, such as granite, whereas in softer rock such as shale a lower pressure will be sufficient (Chapter 6). Detonation pressures of commercial explosives range from 10 kbar to over 140 kbar.

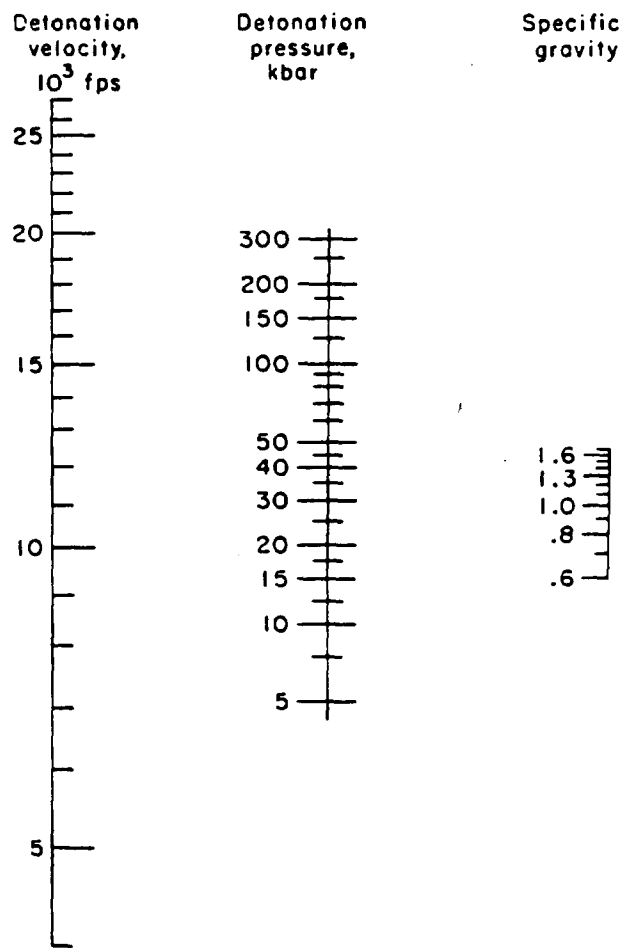

Fig. 3-4. Nomograph for finding detonation pressure⁶

(2) Fig. 3-5 shows the average confined velocity and specific gravity and calculated detonation pressure of explosives.

e. Water Resistance. The water resistance of an explosive is a measure of its ability to withstand exposure to water without deteriorating or losing sensitivity, where sensitivity is the ease with which an explosive will detonate. If water is standing in the blasthole, and the time between loading and firing is fairly short, an explosive with a water resistance rating of "Good" will be sufficient. If the exposure is prolonged or if the water is percolating through the borehole, "Very Good" to "Excellent" water resistance is required. In general, gelatins offer the best water resistance. Higher density dynamites have fair to good water resistance, whereas low-density dynamites have little or none. Emission of brown nitrogen oxide fumes from a blast often means that the explosive has deteriorated from exposure to water and indicates that a change should be made in the choice of explosive or grade.

f. Fume Class.

(1) Detonation of a commercial explosive produces water vapor, carbon dioxide, and nitrogen. Undesirable poisonous gases such as carbon monoxide and nitrogen oxides are usually formed also. These gases are known as fumes, and the fume class of an explosive indicates the nature and quantity of these undesirable gases formed in the detonation process. The ratings, listed in subsequent sections, are based on use underground. Fumes are seldom an important factor for open work.

(2) Removing a cartridge explosive from its cartridge will upset the oxygen balance and unfavorably affect the explosive's fume qualities and blasting efficiency. Water in the blasthole may also have an adverse effect on the fumes produced by a blast, either by causing deterioration of the explosive or by absorbing heat during detonation.

3-3. Ingredients of Explosives. Ingredients of high explosives are classified as explosive bases, combustibles, oxygen carriers, antacids, and absorbents (Table 3-1). Some ingredients perform more than one function. An explosive base is a solid or liquid which, upon the application of sufficient heat or shock, decomposes to gases with an accompanying release of considerable heat. A combustible combines with excess oxygen to prevent the formation of nitrogen oxides. An oxygen carrier assures complete oxidation of the carbon to prevent the formation of carbon monoxide. The formation of nitrogen oxides or carbon monoxide, in addition to being undesirable from the standpoint of fumes, results in lower heat of explosion and efficiency than when carbon dioxide and

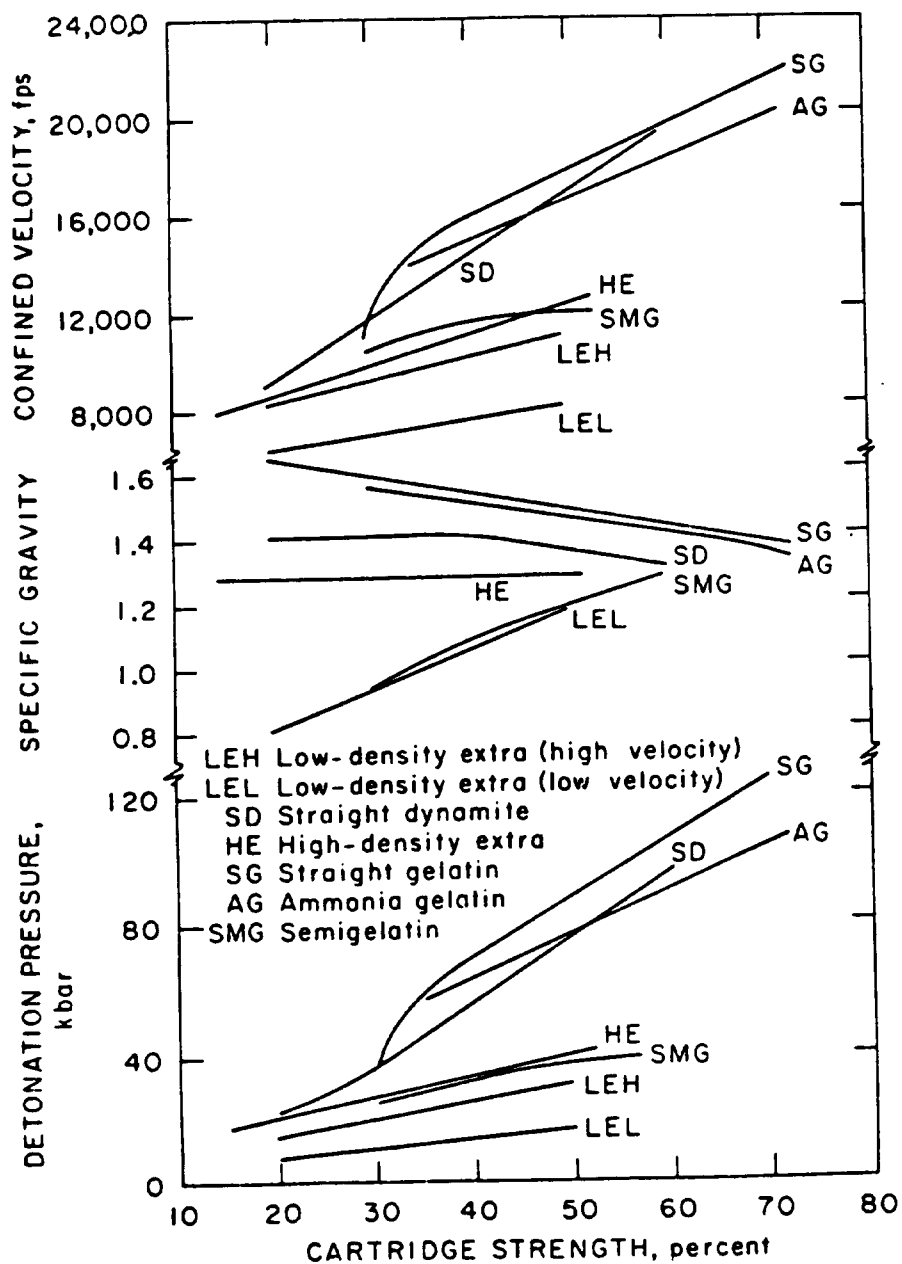

Fig. 3-5. Average confined velocity and specific gravity and calculated detonation pressure of explosives⁶

Table 3-1. Ingredients Used in Explosives

| Ingredient | Chemical Formula | Function |
|-------------------------------------|-------------------------|--|
| Ethylene glycol dinitrate | $C_2H_4(NO_3)_2$ | Explosive base; lowers freezing point |
| Nitrocellulose (guncotton) | $(C_6H_7(NO_3)_3O_2)_n$ | Explosive base; gelatinizing agent |
| Nitroglycerin | $C_3H_5(NO_3)_3$ | Explosive base |
| Tetranitro-diglycerin | $C_6H_{10}N_4O_{13}$ | Explosive base; lowers freezing point |
| Nitro starch | --- | Explosive base; "nonheadache" explosives |
| Organic nitrocompounds | --- | Explosive base |
| Trinitrotoluene (TNT) | $C_7H_5N_3O_6$ | Fuel-sensitizer; used in high-density slurries |
| Metallic powder | Al | Explosive base; deflagrates |
| Black powder | $NaNO_3 + C + S$ | Explosive base; caps, detonating fuse |
| Pentaerythritol tetranitrate (PETN) | $C_5H_8N_4O_{12}$ | Explosive base; used in blasting caps |
| Lead azide | $Pb(N_3)_2$ | Explosive base; formerly used in blasting caps |
| Mercury fulminate | $Hg(ONC)_2$ | Explosive base; oxygen carrier |
| Ammonium nitrate | NH_4NO_3 | Oxygen carrier |
| Liquid oxygen | O_2 | Oxygen carrier |
| Sodium nitrate | $NaNO_3$ | Oxygen carrier |
| Potassium nitrate | KNO_3 | Oxygen carrier |
| Ground coal | C | Combustible |
| Charcoal | C | Combustible |
| Paraffin | C_nH_{2n+2} | Combustible |
| Sulfur | S | Combustible |
| Fuel oil | $(CH_3)_2(CH_2)_n$ | Combustible |
| Wood pulp | $(C_6H_{10}O_5)_n$ | Combustible; absorbent |
| Lampblack | C | Combustible |
| Kieselguhr | SiO_2 | Absorbent; prevents caking |
| Chalk | $CaCO_3$ | Antacid |
| Calcium carbonate | $CaCO_3$ | Antacid |
| Zinc oxide | ZnO | Antacid |
| Sodium chloride | NaCl | Flame depressant (permissible explosives) |

EM 1110-2-3800
1 Mar 72

nitrogen are formed. Antacids increase stability in storage, and absorbents absorb liquid explosive bases.

3-4. Dynamites. The properties and compositions of the various types of dynamites are summarized in Tables 3-2 and 3-3, respectively. Each type is discussed in detail below.

a. Straight Nitroglycerin Dynamite.

(1) Dynamite was originally a mixture of nitroglycerin and diatomite, a porous, inert silica. Today, straight nitroglycerin dynamite consists of nitroglycerin, with sodium nitrate, antacid, carbonaceous fuel, and sometimes sulfur in place of the inert filler. It is most commonly manufactured in weight strengths of 20 to 60 percent. Because of the tendency of nitroglycerin to freeze at low working temperature, another explosive oil usually replaces part of the nitroglycerin in a straight dynamite.

(2) Straight dynamite has a high detonation velocity which gives a shattering action. It resists water well in the higher grades but poorly in the lower grades. Straight dynamite generally has poor fume qualities, and is unsuitable for use underground or in poorly ventilated spaces. The use of straight dynamite has declined because of high cost, sensitivity to shock and friction, and high flammability. Ammonia ("extra") dynamites have replaced straight dynamite in most applications.

(3) Ditching dynamite is a name given to 50 percent straight dynamite. Its high sensitivity is advantageous in ditching where sympathetic detonation eliminates the need for caps or detonating fuse with individual charges. Sixty percent straight dynamite is sometimes packaged in special cartridges for underwater work.

b. High-Density Ammonia (Extra) Dynamite.

(1) Ammonia dynamites (extra dynamite) are the most widely used cartridge explosives. An ammonia dynamite is similar to a straight dynamite except that ammonium nitrate replaces a portion of the nitroglycerin and sodium nitrate.

(2) High-density ammonia dynamite is commonly manufactured in weight strengths of 20 to 60 percent. It is generally lower in detonation velocity, less dense, better in fume qualities, and considerably less sensitive to shock and friction than straight dynamite. Extra dynamite can be used effectively where the rock is not extremely hard and water conditions are not severe. It is widely used in quarrying, stripping, and

1 Mar 72

Table 3-2. Properties⁽¹⁾ of Dynamites

| <u>Weight Strength %</u> | <u>Cartridge Strength %</u> | <u>Specific Gravity</u> | <u>Confined Velocity fps</u> | <u>Water Resistance</u> | <u>Fume Class</u> | <u>Cartridge Count</u> |
|---|-----------------------------|-------------------------|------------------------------|-------------------------|-------------------|------------------------|
| <u>Straight Nitroglycerin Dynamite</u> | | | | | | |
| 60 | 60 | 1.3 | 19,000 | Good | Poor | 106 |
| 50 | 50 | 1.4 | 17,000 | Fair | Poor | 104 |
| 40 | 40 | 1.4 | 14,000 | Fair | Poor | 100 |
| 30 | 30 | 1.4 | 11,500 | Poor | Poor | 100 |
| 20 | 20 | 1.4 | 9,000 | Poor | Poor | 100 |
| <u>High-Density Ammonia Dynamite</u> | | | | | | |
| 60 | 52 | 1.3 | 12,500 | Fair | Good | 110 |
| 50 | 45 | 1.3 | 11,500 | Fair | Good | 110 |
| 40 | 35 | 1.3 | 10,500 | Fair | Good | 110 |
| 30 | 25 | 1.3 | 9,000 | Fair | Good | 110 |
| 20 | 15 | 1.3 | 8,000 | Fair | Good | 110 |
| <u>Low-Density Ammonia Dynamite, High-Velocity Series</u> | | | | | | |
| 65 | 50 | 1.2 | 11,000 | Fair | Fair | 120 |
| 65 | 45 | 1.1 | 10,400 | Fair | Fair | 129 |
| 65 | 40 | 1.0 | 10,000 | Fair | Fair | 135 |
| 65 | 35 | 1.0 | 9,800 | Fair | Fair | 141 |
| 65 | 30 | 0.9 | 9,400 | Poor | Fair | 153 |
| 65 | 25 | 0.9 | 8,800 | Poor | Fair | 163 |
| 65 | 20 | 0.8 | 8,300 | Poor | Fair | 174 |
| <u>Low-Density Ammonia Dynamite, Low-Velocity Series</u> | | | | | | |
| 65 | 50 | 1.2 | 8,100 | Fair | Fair | 120 |
| 65 | 45 | 1.1 | 7,800 | Poor | Fair | 129 |
| 65 | 40 | 1.0 | 7,500 | Poor | Fair | 135 |
| 65 | 35 | 1.0 | 7,200 | Poor | Fair | 141 |
| 65 | 30 | 0.9 | 6,900 | Poor | Fair | 153 |
| 65 | 25 | 0.9 | 6,500 | Poor | Fair | 163 |
| 65 | 20 | 0.8 | 6,300 | Poor | Fair | 174 |

Note: Values shown are the averages of several manufacturers.

(1) Specific gravity and confined detonation velocity can be used to calculate characteristic impedance which is useful in choosing the explosive for a given rock as explained in paragraph 6-2.

1 Mar 72

Table 3-3. Composition⁽¹⁾ of Dynamites

| Component | Weight Strength | | | | | |
|--|-----------------|------|------|------|------|------|
| | 20% | 30% | 40% | 50% | 60% | 100% |
| <u>Straight Nitroglycerin Dynamite</u> | | | | | | |
| Nitroglycerin | 20.2 | 29.0 | 39.0 | 49.0 | 56.8 | -- |
| Sodium nitrate | 59.3 | 53.3 | 45.5 | 34.4 | 22.6 | -- |
| Carbonaceous fuel | 15.4 | 13.7 | 13.8 | 14.6 | 18.2 | -- |
| Sulfur | 2.9 | 2.0 | -- | -- | -- | -- |
| Antacid | 1.3 | 1.0 | 0.8 | 1.1 | 1.2 | -- |
| Moisture | 0.9 | 1.0 | 0.9 | 0.9 | 1.2 | -- |
| <u>High-Density Ammonia Dynamite</u> | | | | | | |
| Nitroglycerin | 12.0 | 12.6 | 16.5 | 16.7 | 22.5 | -- |
| Sodium nitrate | 57.3 | 46.2 | 37.5 | 25.1 | 15.2 | -- |
| Ammonium nitrate | 11.8 | 25.1 | 31.4 | 43.1 | 50.3 | -- |
| Carbonaceous fuel | 10.2 | 8.8 | 9.2 | 10.0 | 8.6 | -- |
| Sulfur | 6.7 | 5.4 | 3.6 | 3.4 | 1.6 | -- |
| Antacid | 1.2 | 1.1 | 1.1 | 0.8 | 1.1 | -- |
| Moisture | 0.8 | 0.8 | 0.7 | 0.9 | 0.7 | -- |

(1) Values shown are in percent by weight and are the averages of several manufacturers.

in well-ventilated mines for smaller diameter holes of small blasting operations.

c. Low-Density Ammonia (Extra) Dynamite.

(1) Low-density ammonia dynamite has a weight strength of approximately 65 percent and a cartridge strength from 20 to 50 percent. Like a high-density extra dynamite, it contains a low proportion of nitroglycerin and a high proportion of ammonium nitrate. The different cartridge strengths are obtained by varying the density and grain size of the ingredients.

(2) Several manufacturers produce two series of low-density ammonia dynamite, a high- and a low-velocity series. Both series are of lower velocity and density than high-density extra dynamite. Because of its slow, heaving action, the low-velocity series is well suited to blasting soft material such as clay-shale or where a coarse product such as riprap is desired. It is well suited for use in structural

excavation blasting in certain rock types.

(3) Fume qualities and water resistance vary with the cartridge material. Wrappers sprayed with paraffin give fair to poor water resistance and fair fume rating, whereas a paraffin-impregnated wrapper gives very poor water resistance and a better fume rating. The explosive has little more water resistance than that provided by the wrapper. Low-density extra is the lowest cost cartridge explosive available.

(4) The composition of low-density ammonia dynamites is similar to that of a 60 percent high-density extra dynamite with a lower proportion of nitroglycerin and a higher proportion of ammonium nitrate. Table 3-2 lists the properties of the high- and low-velocity series, with paraffin-sprayed cartridge.

3-5. Gelatins. The properties and compositions of the various types of gelatins are summarized in Tables 3-4 and 3-5, respectively. Each type is discussed in detail below.

a. Blasting Gelatin. Blasting gelatin is a rubber-textured explosive made by adding nitrocellulose (guncotton) to nitroglycerin. An antacid is added for stability in storage. Wood meal is usually added to improve sensitivity, although this is not indicated in Table 3-5. Blasting gelatin attains a very high detonation velocity and has excellent water resistance, but it emits large volumes of noxious fumes upon detonation. It is the most powerful of all commercial explosives. Blasting gelatin is also known as "oil well explosive."

b. Straight Gelatin.

(1) Straight gelatin is a dense, plastic explosive consisting of nitroglycerin or other explosive oil gelatinized with nitrocellulose, an antacid, sodium nitrate, carbonaceous fuel, and sometimes sulfur. Since the gelatin tends to coat the other ingredients, straight gelatin is waterproof. Straight gelatin is the equivalent of straight dynamite in the dynamite category and is manufactured in weight strengths of 20 to 90 percent with corresponding cartridge strengths of 30 to 80 percent. The cartridge strength or the weight strength may be referred to by the manufacturer as the "grade" of the gelatin, a term which is confusing. Straight gelatin has been used in very hard rock or as a bottom charge in a column of explosives. It has been replaced in most applications by a more economical substitute such as ammonia gelatin, but higher grades are still used in underwater blasting and in deep well shooting.

(2) Straight gelatin has two characteristic detonation velocities,

Table 3-4. Properties⁽¹⁾ of Gelatins

| <u>Weight Strength %</u> | <u>Cartridge Strength %</u> | <u>Specific Gravity</u> | <u>Confined Velocity fps</u> | <u>Water Resistance</u> | <u>Fume Class</u> | <u>Car- tridge Count</u> |
|----------------------------------|-------------------------------------|-----------------------------|--------------------------------------|-----------------------------|-----------------------|----------------------------------|
| <u>Blasting Gelatin</u> | | | | | | |
| 100 | 90 | 1.3 | 25,000- 26,000 | Excellent | Poor | 110 |
| <u>Straight Gelatin</u> | | | | | | |
| 90 | 80 | 1.3 | 23,000 | Excellent | Poor | 105 |
| 70 | 70 | 1.4 | 21,000 | Excellent | Poor | 101 |
| 60 | 60 | 1.4 | 20,000 | Excellent | Good | 98 |
| 50 | 55 | 1.5 | 18,500 | Excellent | Good | 95 |
| 40 | 45 | 1.5 | 16,500 | Excellent | Good | 92 |
| 30 | 35 | 1.6 | 14,500 | Excellent | Good | 88 |
| 20 | 30 | 1.7 | 11,000 | Excellent | Good | 85 |
| <u>Ammonia Gelatin</u> | | | | | | |
| 80 | 72 | 1.3 | 20,000 | Excellent | Good | 106 |
| 70 | 67 | 1.4 | 19,000 | Excellent | Very good | 102 |
| 60 | 60 | 1.4 | 17,500 | Excellent | Very good | 100 |
| 50 | 52 | 1.5 | 16,500 | Excellent | Very good | 97 |
| 40 | 45 | 1.5 | 16,000 | Excellent | Very good | 92 |
| 30 | 35 | 1.6 | 14,000 | Excellent | Very good | 90 |
| <u>Semigelatin</u> | | | | | | |
| 63 | 60 | 1.3 | 12,000 | Very good | Very good | 110 |
| 63 | 50 | 1.2 | 12,000 | Very good | Very good | 118 |
| 63 | 40 | 1.1 | 11,500 | Good | Very good | 130 |
| 63 | 30 | 0.9 | 10,500 | Fair | Very good | 150 |

Note: Values shown are the averages of several manufacturers.

(1) Specific gravity and confined detonation velocity can be used to calculate characteristic impedance which is useful in choosing the explosive for a given rock as explained in paragraph 6-2.

1 Mar 72

Table 3-5. Composition⁽¹⁾ of Gelatins

| Component | Weight Strength | | | | | |
|-------------------------|-----------------|------|------|------|------|------|
| | 20% | 30% | 40% | 50% | 60% | 100% |
| <u>Blasting Gelatin</u> | | | | | | |
| Nitroglycerin | -- | -- | -- | -- | -- | 91.0 |
| Nitrocellulose | -- | -- | -- | -- | -- | 7.9 |
| Antacid | -- | -- | -- | -- | -- | 0.9 |
| Moisture | -- | -- | -- | -- | -- | 0.2 |
| <u>Straight Gelatin</u> | | | | | | |
| Nitroglycerin | 20.2 | 25.4 | 32.0 | 40.1 | 49.6 | -- |
| Sodium nitrate | 60.3 | 56.4 | 51.8 | 45.6 | 38.9 | -- |
| Nitrocellulose | 0.4 | 0.5 | 0.7 | 0.8 | 1.2 | -- |
| Carbonaceous fuel | 8.5 | 9.4 | 11.2 | 10.0 | 8.3 | -- |
| Sulfur | 8.2 | 6.1 | 2.2 | 1.3 | -- | -- |
| Antacid | 1.5 | 1.2 | 1.2 | 1.2 | 1.1 | -- |
| Moisture | 0.9 | 1.0 | 0.9 | 1.0 | 0.9 | -- |
| <u>Ammonia Gelatin</u> | | | | | | |
| Nitroglycerin | -- | 22.9 | 26.2 | 29.9 | 35.3 | -- |
| Nitrocellulose | -- | 0.3 | 0.4 | 0.4 | 0.7 | -- |
| Sodium nitrate | -- | 54.9 | 49.6 | 43.0 | 33.5 | -- |
| Ammonium nitrate | -- | 4.2 | 8.0 | 13.0 | 20.1 | -- |
| Carbonaceous fuel | -- | 8.3 | 8.0 | 8.0 | 7.9 | -- |
| Sulfur | -- | 7.2 | 5.6 | 3.4 | -- | -- |
| Antacid | -- | 0.7 | 0.8 | 0.7 | 0.8 | -- |
| Moisture | -- | 1.5 | 1.4 | 1.6 | 1.7 | -- |

(1) Values shown are in percent by weight and are the averages of several manufacturers.

the confined velocity and a much lower velocity which results from insufficient confinement, insufficient initiation, or high hydrostatic pressure. Extremely high water pressures may cause a misfire. To overcome this disadvantage, high-velocity gelatin has been developed. High-velocity gelatin is very similar to straight gelatin except that it is slightly less dense, more sensitive to detonation, and always detonates near its rated velocity regardless of water pressure or degree of confinement. High-velocity gelatin is particularly useful as a seismic explosive, and is also used in deep well and underwater work.

1 Mar 72

c. Ammonia Gelatin. Ammonia gelatin (special gelatin or gelatin extra) has a portion of the nitroglycerin and sodium nitrate replaced by ammonium nitrate. Ammonia gelatin is comparable to a straight gelatin in the same way that a high-density ammonia dynamite is comparable to a straight dynamite, and was developed as a cheaper substitute. Ammonia gelatin is commonly manufactured in weight strengths of 30 to 80 percent with corresponding cartridge strengths of 35 to 72 percent. Compared with straight gelatin, ammonia gelatin has a somewhat lower detonation velocity, better fume qualities, and less water resistance, although it will fire efficiently even after standing in water for several days. It is suitable for underground work because of its good fume rating. The higher strengths (70 percent or higher) are efficient as primers (para 3-8c) for blasting agents.

d. Semigelatin. A semigelatin is comparable to an ammonia gelatin as a low-density ammonia dynamite is comparable to a high-density ammonia dynamite. Like low-density extras, semigelatin has a uniform weight strength (60 to 65 percent) with the cartridge strength varying with the density and grain size of the ingredients. Its properties fall between those of high-density ammonia dynamite and ammonia gelatin, and it has great versatility. Semigelatin can be used to replace ammonia dynamite when more water resistance is needed. It is cheaper for wet work than ammonia gelatin, although its water resistance is not quite as high as that of ammonia gelatin. Semigelatin has a confined detonation velocity of 10,000 to 12,000 fps, which, in contrast to that of most explosives, is not seriously affected by lack of confinement. Very good fume qualities permit its use underground. The compositions are similar to ammonia gelatin with less nitroglycerin and sodium nitrate and more ammonium nitrate.

3-6. Blasting Agents (Nitrocarbonitrates). Blasting agents consist of mixtures of fuels and oxidizers, none of which are classified as explosive, which cannot be detonated by a No. 8 test blasting cap as packaged for shipment. Nitrocarbonitrate is a classification given to a blasting agent under the U. S. Department of Transportation regulations on packaging and shipping. A blasting agent consists of inorganic nitrates and carbonaceous fuels and may contain additional nonexplosive substances such as powdered aluminum or ferrosilicon to increase density. The addition of an explosive ingredient such as TNT (para 3-7a) changes the classification from a blasting agent to an explosive. Blasting agents may be dry or in slurry forms. Because of their insensitivity, blasting agents should be detonated by a primer (para 3-8) of high explosive. Ammonium nitrate-fuel oil (ANFO) has largely replaced dynamites and gelatins in bench blasting. Denser slurry blasting agents are supplanting dynamite and gelatin and dry blasting agents.

a. Dry Blasting Agents.

(1) The most widely used dry blasting agent is a mixture of ammonium nitrate prills (porous grains) and fuel oil. A properly balanced ANFO mixture detonates as follows:

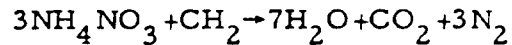

The fuel oil is not precisely CH_2 , but this is sufficiently accurate to characterize the reaction. The right side of the equation contains only the desirable gases of detonation, although some CO and NO_2 are always formed. Weight proportions of ingredients for the equation are 94.5 percent ammonium nitrate and 5.5 percent fuel oil. In actual practice the proportions are 94 percent and 6 percent to assure an efficient chemical reaction of the nitrate.

(2) Uniform mixing of oil and ammonium nitrate is essential to development of full explosive force. Some blasting agents are premixed and packaged by the manufacturer. Where not premixed, several methods of mixing in the field can be employed to achieve uniformity. The best method, although not always the most practical one, is by mechanical mixer. A more common and almost as effective method of mixing is by uniformly soaking prills in opened bags with 8 to 10 percent of their weight of oil. After draining for at least a half hour the prills will have retained about the correct amount of fuel oil.

(3) Fuel oil can also be poured onto the ammonium nitrate in approximately the correct proportions as it is poured into the blasthole. For this purpose, about 1 gal of fuel oil for each 100 lb of ammonium nitrate will equal approximately 6 percent by weight of oil. The oil can be added after each bag or two of prills, and it will disperse relatively rapidly and uniformly.

(4) Inadequate priming imparts a low initial detonation velocity to a blasting agent, and the reaction may die out and cause a misfire. High explosive boosters are sometimes spaced along the borehole to assure propagation throughout the column. In charge diameters of 6 in. or more, dry blasting agents attain confined detonation velocities of more than 12,000 fps, but in a diameter of 1-1/2 in., the velocity is reduced to 60 percent (Table 3-6).

(5) Advantages of insensitive dry blasting agents are their safety, ease of loading, and low price. In the free-flowing form, they have a great advantage over cartridge explosives because they completely fill

Table 3-6. Confined Detonation Velocity, and
Charge Concentration of ANFO

| Borehole Diameter in. | Confined Velocity ⁽¹⁾ fps | Charge Concentration lb/ft of Borehole |
|--------------------------|---|--|
| 1-1/2 | 7,000- 9,000 | 0.6- 0.7 |
| 2 | 8,500- 9,900 | 1.1- 1.3 |
| 3 | 10,000-10,800 | 2.5- 3.0 |
| 4 | 11,000-11,800 | 4.4- 5.2 |
| 5 | 11,500-12,500 | 6.9- 8.2 |
| 6 | 12,000-12,800 | 9.9-11.7 |
| 7 | 12,300-13,100 | 13.3-15.8 |
| 8 | 12,500-13,300 | 17.6-20.8 |
| 9 | 12,800-13,500 | 22.0-26.8 |
| 10 | 13,000-13,500 | 27.2-32.6 |
| 11 | 13,200-13,500 | 33.0-39.4 |
| 12 | 13,300-13,500 | 39.6-46.8 |

(1) Confined detonation velocity can be used to calculate characteristic impedance which is useful in choosing the explosive for a given rock as explained in paragraph 6-2.

the borehole. This direct coupling to the walls assures efficient use of explosive energy. Ammonium nitrate is water soluble so that in wet holes, some blasters pump the water from the hole, insert a plastic sleeve, and load the blasting agent into the sleeve. Special precautions should be taken to avoid a possible building up of static electrical charge, particularly when loading pneumatically. When properly oxygen-balanced, the fume qualities of dry blasting agents permit their use underground. Canned blasting agents, once widely used, have unlimited water resistance, but lack advantages of loading ease and direct coupling to the borehole.

(6) The specific gravity of ANFO varies from 0.75 to 0.95 depending on the particle density and sizes. Table 3-6 shows how confined detonation velocity and charge concentration of ANFO vary with borehole diameter. Pneumatic loading results in high detonation velocities and higher charge concentrations, particularly in holes smaller than 3 in. (otherwise such small holes are not usually recommended for ANFO blasting).

b. Slurries.

(1) Slurries, sometimes called water gels, contain ammonium

1 Mar 72

nitrate partly in aqueous solution. Depending on the remainder of the ingredients, slurries can be classified as either blasting agents or explosives. Slurry blasting agents contain nonexplosive sensitizers or fuels such as carbon, sulfur, or aluminum, and are not cap sensitive; whereas slurry explosives contain cap-sensitive ingredients such as TNT and the mixture itself may be cap sensitive. Slurries are thickened and gelled with a gum, such as guar gum, to give considerable water resistance.

(2) Since most slurries are not cap sensitive, all slurries, even those containing TNT, are often grouped under the term blasting agent. This grouping is incorrect. A blasting agent, as defined by the National Fire Protection Association, shall contain no ingredient that is classified as an explosive.

(3) Slurry blasting agents require adequate priming with a high-velocity explosive to attain proper detonation velocities, and often require boosters of high explosive spaced along the borehole to assure complete detonation. Slurry explosives may or may not require priming. The detonation velocities of slurries, between 12,000 and 18,000 fps, vary with ingredients used, charge diameter, degree of confinement, and density. The detonation velocity of a slurry, however, is not as dependent on charge diameter as that of a dry blasting agent. The specific gravity varies from 1.1 to 1.6. The consistency of most slurries ranges from fluid near 100° F to rigid at freezing temperatures, although some slurries maintain their fluidity even at freezing temperatures. Slurries consequently give the same advantageous direct borehole coupling as dry blasting agents as well as a higher detonation velocity and a higher density. Thus, more energy can be loaded into a given volume of borehole. Saving in costs realized by drilling smaller holes or using larger burden and spacing (see definitions in para 5-2a) will often more than offset the higher cost per pound of explosive. Adding powdered aluminum as a sensitizer to slurries greatly increases the heat of explosion or the energy release. Aluminized slurries have been used in extremely hard rock with excellent results.

(4) A slurry and a dry blasting agent may be used in the same borehole in "slurry boosting," with the bulk of the charge being dry blasting agent. Boosters placed at regular intervals may improve fragmentation. In another application of slurry boosting, the slurry is placed in a position where fragmentation is difficult, such as a hard toe or a zone of hard rock in the burden. The combination will often give better overall economy than straight slurry or dry blasting agent.

1 Mar 72

3-7. Other Explosives.

a. TNT. Trinitrotoluene, $C_7H_5N_3O_6$ (TNT), is a stable, cap-sensitive compound (not extremely sensitive) that has excellent water resistance. Cast TNT has a specific gravity of 1.56 and a confined detonation velocity of about 22,000 fps, and is used as a primer and booster for blasting agents. It is also used in the pelletized form where a free-running explosive with high density and good water resistance is needed. One of the principal uses of TNT at present is as a sensitizer for slurries.

b. PETN. Pentaerythritol tetranitrate, $C_5H_8N_4O_{12}$ (PETN), has a specific gravity of solids of 1.76 and a confined detonation velocity of over 25,000 fps. PETN is used as a priming composition in detonators, a base charge in blasting caps, and a core load for detonating fuse (para 3-8b).

c. Pentolite. Pentolite is a mixture of equal parts of TNT and PETN. When cast, it has a specific gravity of 1.65 and a confined detonation velocity of 24,000 to 25,000 fps. Cast pentolite is used as a primer and booster for blasting agents where its high detonation pressure assures efficient initiation of the blasting agent.

d. RDX. Cyclotrimethylenetrinitramine, $C_3H_6N_6O_6$ (RDX), is second in strength to nitroglycerin among common explosive substances. When compressed to a specific gravity of 1.70, it has a confined detonation velocity of about 27,000 fps. RDX is the primary ingredient in the explosive mixtures C-3, C-4, and Composition B. RDX is used as the base charge for some detonators.

e. Composition B. Composition B is a mixture of RDX and TNT with about 1 percent wax added. Cast Composition B has a specific gravity of 1.65 and a detonation velocity of about 25,000 fps and is used as a primer and booster for blasting agents.

f. Permissible Explosives. A permissible explosive is one designed for use where explosive gases and dusts may be encountered such as in coal mines. They must be properly oxygen-balanced to pass the test for poisonous fumes. Sodium chloride or some other flame depressant is usually added to the explosive to lower its heat of explosion and minimize the chance of ignition of gas or coal dust.

g. Black Powder. On CE projects the use of black powder (for composition, see Table 3-1) is prohibited except specially formulated black powders, commonly containing additional inert ingredients, used as the core load of safety fuse. These powders are finely ground and

compacted sufficiently to give a prescribed rate of burning.

3-8. Detonators and Primers.

a. Blasting Caps.

(1) Electric blasting caps, the most commonly used initiating device, may be inserted directly into the explosive cartridge or used with detonating fuse (Fig. 3-6). An electric blasting cap consists of two insulated leg wires inserted in an insulated metal capsule and connected by a thin-filament bridge wire. When sufficient current is applied through the leg wires, the bridge wire gives off heat energy and ignites a flash charge of heat-sensitive explosive. The explosion of the flash charge detonates a primer charge, which in turn detonates a base charge of powerful explosive such as PETN or RDX. In some caps the flash and primer charges are combined. The base charge of the cap detonates with sufficient force to initiate a cap-sensitive explosive or detonating fuse.

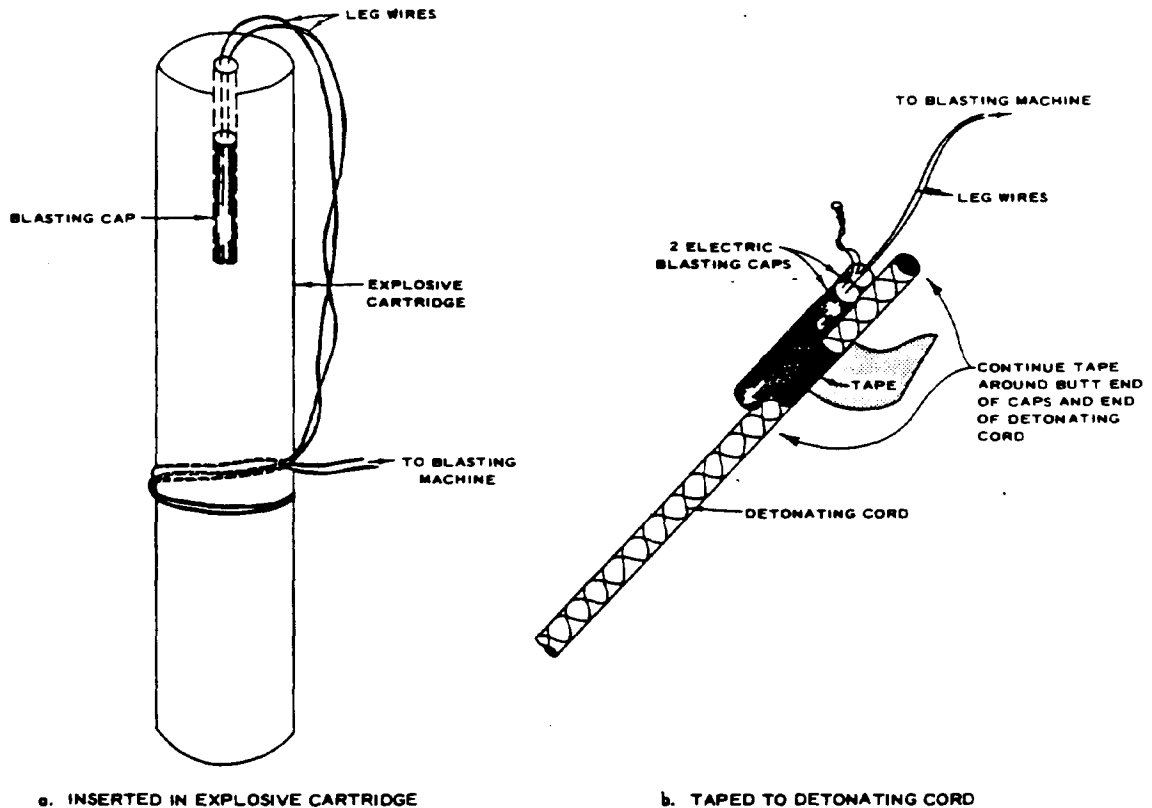

Fig. 3-6. Application of blasting caps (in part from Du Pont⁸)

1 Mar 72

(2) Advantages of electric blasting caps include safety in handling, variety of delay periods available, and choice of exact time of detonation. Noise and potential public relations problems are reduced by initiating the charge in the borehole with a blasting cap instead of using trunk lines and down lines of detonating fuse. Care should be used to avoid stray, induced electric currents or those caused by lightning or radio frequency energy (see para 1-3). Manufacturer's data should be consulted for current requirements. Because of variation from brand to brand, mixing brands of caps in a round should not be done.

(3) A delay element of explosive is placed between the bridge wire and the primer charge in a delay electric cap. The delay element is accurately calibrated to give a specified time lapse between the application of electric current and the detonation. Two series of delays are available: short or millisecond delays, with delay increments of 25 msec in the lower range and 50 msec in the upper range; and longer delays, often called slow delays, with delay increments of 0.5 and 1 sec. Where maximum fragmentation is desired, millisecond delays are used to produce good breakage and reduce airblast and ground vibrations. Slow delays are primarily used underground where they provide time for rock movement between delays. Longer delays are likely to result in coarser fragmentation than that obtained with millisecond delays.

(4) The cap and fuse is another system of initiating explosives. A fuse cap is a small tube, closed at one end, which contains a heat-sensitive primer charge plus a base charge such as PETN. The cap has an open space above the primer charge into which the safety fuse is inserted (Fig. 3-7). The safety fuse consists of a core of potassium nitrate black powder enclosed in a covering of textile and waterproofing compound. The several types of fuses vary in water resistance and flexibility. Most burn at 40 seconds per foot (spf), but some burn at 30 spf. The safety fuse is butted to the charge in the cap and crimped to form a tight bond. Cap and fuse systems, used primarily underground where rotational firing is necessary, can give an unlimited number of slow delay intervals. The caps are more dangerous to handle than electric caps because the highly sensitive explosive charge is exposed. Mishandling of the fuse can cause a change in the burning rate. High degree of confinement increases the burning rate; high altitude decreases the burning rate. Rates should always be determined at the site.

b. Detonating Fuse.

(1) A detonating fuse, also called detonating cord, consists of a core of high explosive, usually PETN, within a waterproof plastic sheath enclosed in a reinforcing cover. Reinforcing covers come in a variety

1 Mar 72

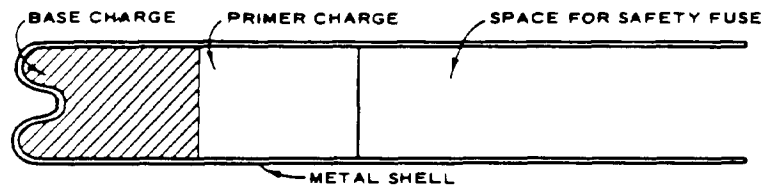

a. CAP (SECTION)

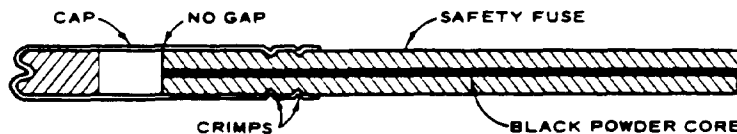

b. FUSE PROPERLY INSERTED IN CAP (SECTION)

*(Courtesy of E. I. du Pont de Nemours & Co.)*Fig. 3-7. Safety fuse and cap
(modified from Du Pont⁸)

of types and tensile strengths suitable for different blasting conditions. Detonating fuses with core loadings ranging from 1 to 400 grains per foot (gr/ft) of PETN are available with 25- and 50-gr/ft loads most commonly used. All grades can be detonated with a blasting cap and have a detonation velocity of approximately 21,000 fps.

(2) The marked insensitivity to external shock and friction makes a detonating fuse ideal for both down lines and trunk lines for primary blasting. Since the blasting cap need not be connected into the circuit until just prior to the time of firing, most of the hazard of premature detonation is eliminated. Detonating fuses with loads of 25 or 50 gr/ft will detonate any cap-sensitive explosive and are very useful when blasting with deck charges (para 5-2c) or when using multiple boosters with blasting agents. A detonating fuse with a core loading of 50 gr/ft will not detonate a blasting agent.

(3) Detonating fuses have wide application in underwater work, but the ends of the detonating fuse should be protected from water. PETN will slowly absorb water and as a result become insensitive to initiation. Even when damp, however, a detonating fuse will detonate if initiated on a dry end.

(4) Millisecond delay connectors are available for use with detonating fuses. Each connector consists of a delay element with a length of detonating fuse connected to each end. The connectors are tied

between two ends of the detonating fuse in the trunk line and permit the use of an unlimited number of delay periods (Fig. 3-8). Delay connectors are commonly available in periods of 5, 9, and 17 msec.

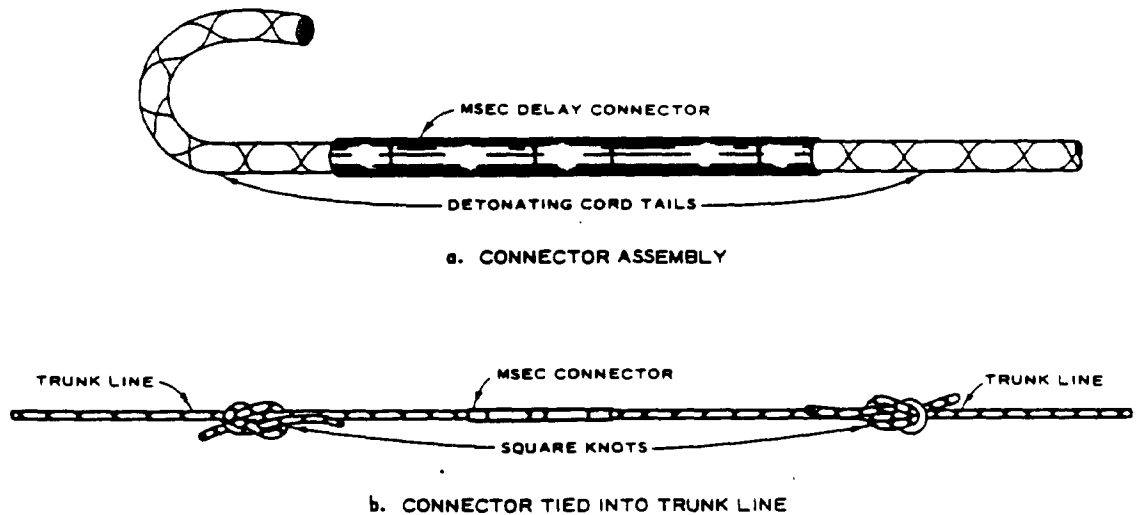

Fig. 3-8. Millisecond delay connectors

(5) A detonating fuse with a core load of 1 to 5 gr/ft of PETN, known as low-energy detonating cord (LEDC), has two principal uses. The first is where airblast from a trunk line presents a problem. LEDC produces virtually no airblast. The second use is as a down line where center or bottom initiation is desired. Since LEDC will not detonate commercial cap-sensitive explosives, it must be used in conjunction with special connectors and blasting caps. This system requires the exercise of extreme care to prevent misfires.

c. Primers and Boosters.

(1) A primer is a cartridge of explosive used in conjunction with a cap or detonating fuse to initiate the detonation of a blasting agent. Primers are necessary in using blasting agents in order to attain high detonation pressure and temperature rapidly and thereby to increase efficiency of the main detonation. Three characteristics of an efficient primer are high detonation pressure, adequate size, and high detonation velocity. High velocity, high strength dynamite is commonly used.

(2) A booster has no cap or fuse and merely assures propagation of the detonation.

CHAPTER 4. DRILLING

4-1. Introduction.

a. Factors in selecting a drilling method include rock type, site conditions, scale of operations, hole diameter, hole depth, and labor and equipment costs. Factors in predicting drilling rates include machine capability and operations, type of bit, flushing, and rock type.

b. The basic purpose of drill holes in construction is for emplacement of explosives. The use of these same holes and cuttings removed from them in modifying and updating the knowledge of the project's subsurface conditions, however, should not be overlooked. The sources of some of the data in this chapter are references 5 and 9.

4-2. Principles of Drilling.

a. The common drill systems in use today are rotary, percussive, and rotary-percussive systems. Each is distinguished by its method of attack on the rock. A fourth system, jet-piercing, is used in the mining industry but has not yet become a standard method in civil excavation and will not be discussed further.

b. Drill bits may be classified by the shape of the cutting surface as conical, hemispherical, pyramidal, and prismatic. Applied forces transmitted to the rock through the bit are concentrated in the area of contact. The stresses at the contact and underneath break the rock. Experiments simulating the cutting actions of percussive and rotary drill bits indicate that rock fails in three distinct modes: crushing, chipping, and spalling (Fig. 4-1). Crushing and chipping are essentially static processes whereas spalling is caused by stress waves.² Stresses under a chisel bit are essentially compressional.¹⁰ Crushing apparently results from failure of rock in a state of triaxial compression; chipping is due to fractures propagating from the vicinity of the crushed zone. Because of their significant effects on compressive strength of rock in general, the quartz content¹¹ and the porosity¹² (Figs. 4-2 and 4-3) are useful parameters for estimating drillability.

c. Analysis of the mechanics of drilling systems reveals limitations of each and indicates the most promising system for a specific type of rock. For example, a rock with a high compressive strength, regardless of its abrasiveness, is likely to respond well to the crushing-chipping action of a percussive bit. On the other hand, a relatively weakly bonded rock may not respond much better to percussive action, but will give good performance for a wear-resistant rotary drag bit (para 4-3c). A rule of thumb for choosing drilling methods in different

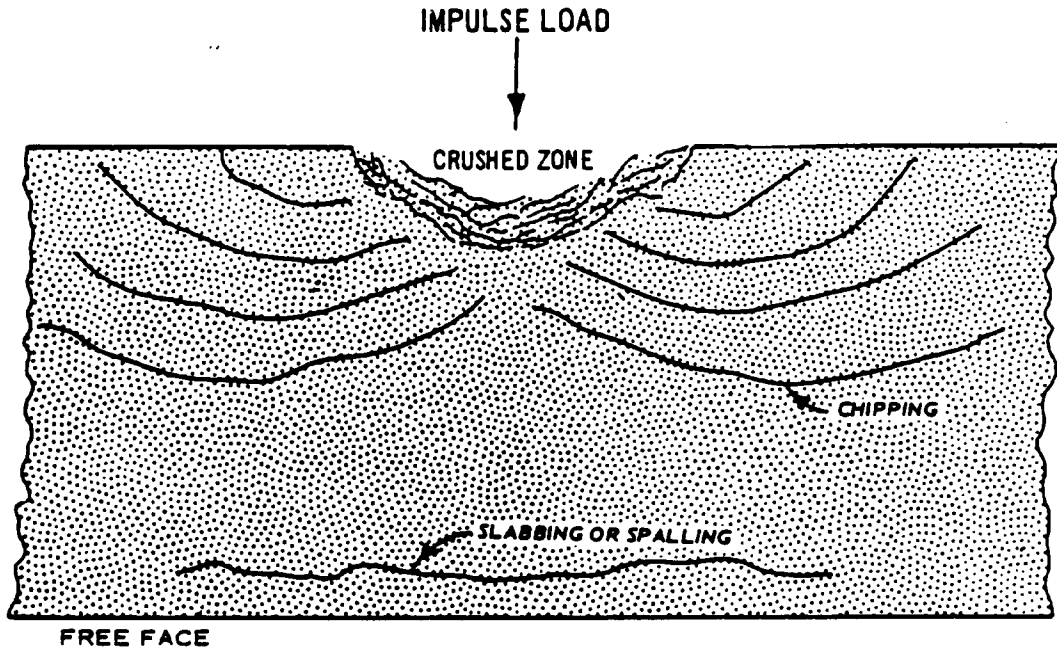

Fig. 4-1. Types of failure induced by a drill bit²

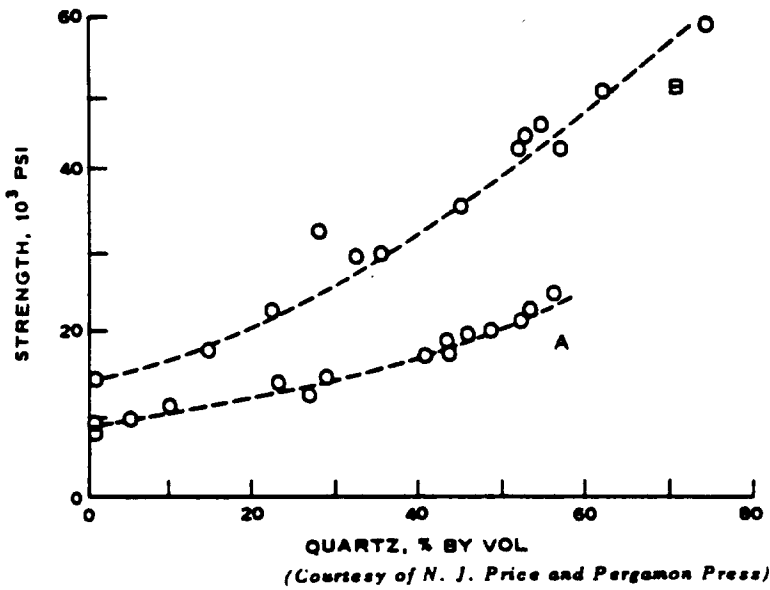

Fig. 4-2. Relation between quartz content and uniaxial strength of sedimentary rock. Curve A refers to rock with clay mineral matrices whose strengths have been corrected to eliminate the effects of compaction. Curve B represents rock types with carbonate matrices¹¹

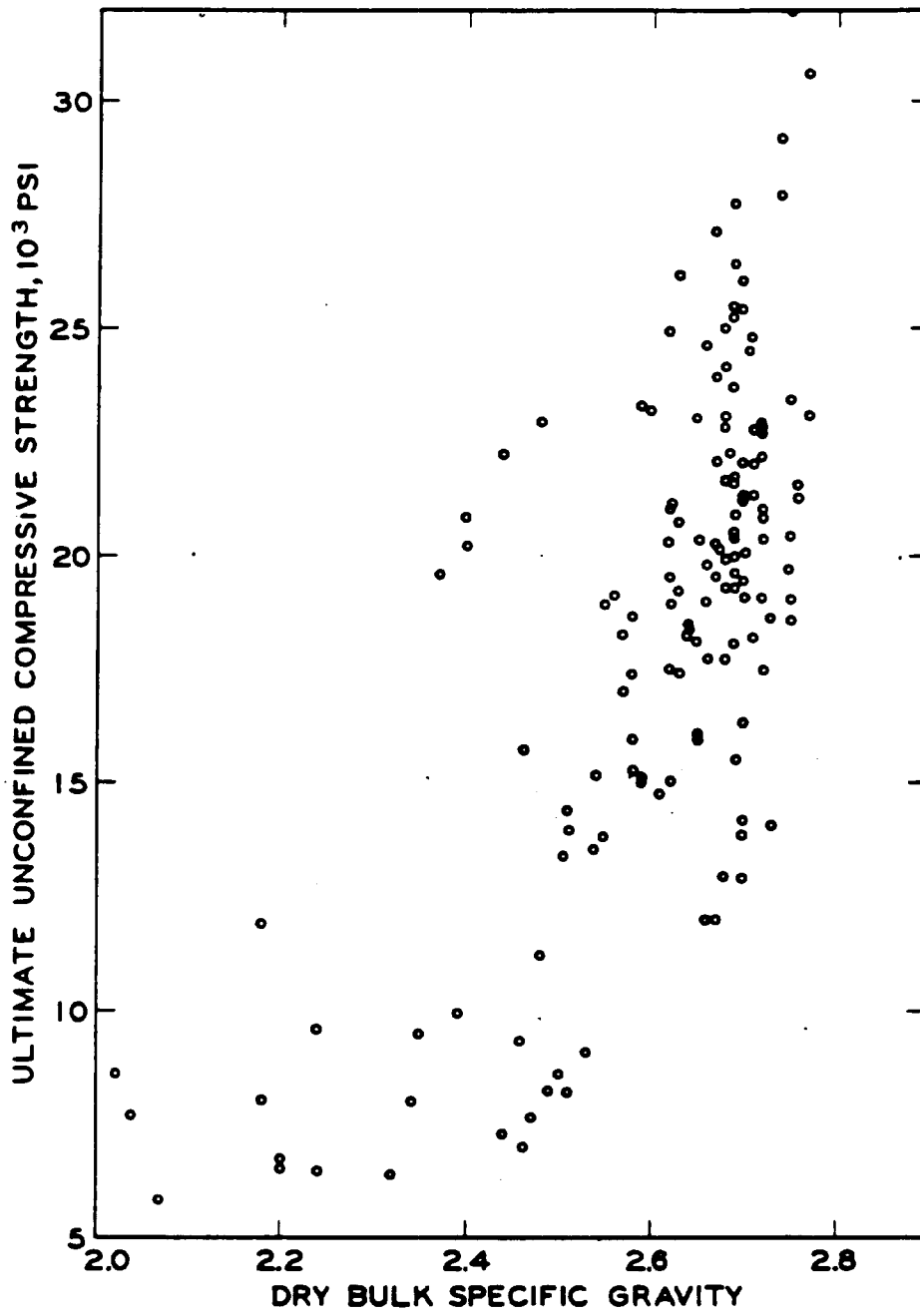

Fig. 4-3. Relation of compressive strength and bulk specific gravity for basalt¹²

1 Mar 72

rocks is shown in Table 4-1. A tendency for manufacturers to improve their machines and bits may allow each system to drill slightly more resistant rock than shown.

Table 4-1. Recommended Drilling Systems for Rock of Different Strengths⁵

| System | Resistance of Rock to Penetration | | | |
|--------------------|-----------------------------------|--------|------|-----------|
| | Soft | Medium | Hard | Very Hard |
| Rotary-drag bit | X | X | | |
| Rotary-roller bit | X | X | X | |
| Rotary-diamond bit | X | X | X | X |
| Percussive | X | X | X | X |
| Rotary-percussive | X | X | X | |

4-3. Rotary Drills. The rotary drill (Fig. 4-4) imparts two basic actions through the bit into the rock: axial thrust and torque. Each machine has an optimum axial thrust interrelated with the available torque for a maximum penetration rate in a specific rock. Operating below the optimum thrust results in a decrease in penetration rate and may impart a polishing or grinding action. Operating above the optimum thrust requires high torque and tends to stall the machine. Rotary drills have higher torque than either percussive or rotary-percussive drills and require high sustained thrust. Rotary drills can be distinguished on the basis of the bit type. These are roller bits, diamond bits, and drag bits.

a. Roller Bits. Roller bits penetrate the rock mainly by crushing and chipping. They have conical cutters usually of sintered tungsten carbide that revolve around axles attached to the bit body. When the load is applied, the cutters roll on the bottom of the hole as the drill stem is rotated. Fig. 4-5 illustrates rock bits used for soft, medium, hard, and very hard formations. Roller bits are readily available in sizes ranging from 3 to 26 in. in diameter.

b. Diamond Bits. Diamond bits include those which cut full holes (plug bits) and those which take a core. In drilling with diamond bits, the hole is advanced by abrasive scratching and plowing action. The bit is generally cylindrical in shape with diamonds set in the contact area (Fig. 4-6). Arrangement and size of diamonds and location of water-flushing channel are determined by the rock to be drilled.

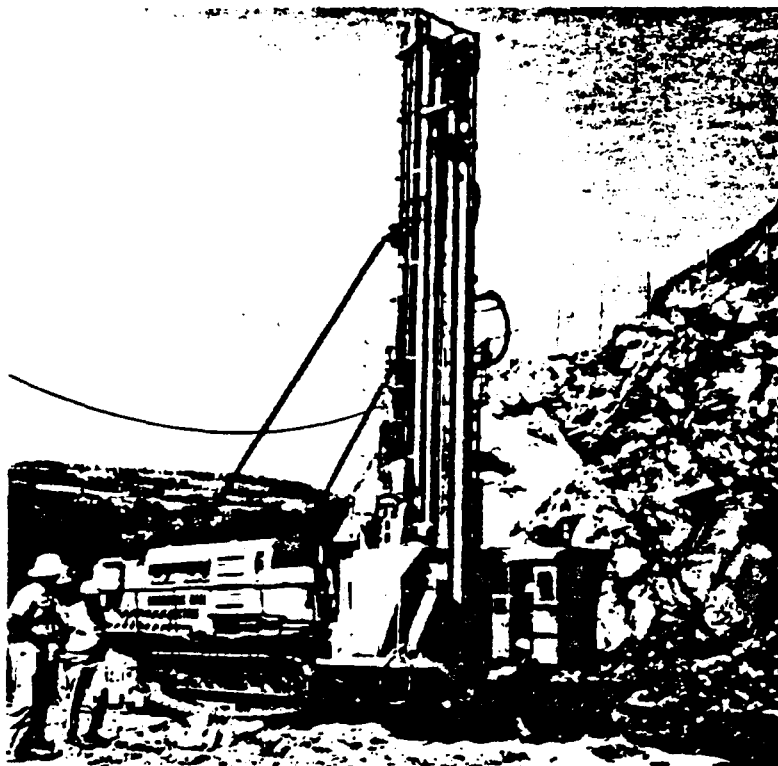

Fig. 4-4. Track-mounted rotary drill (9-in. bit)

Diamond bits require greater rotation speed but less bit pressure than roller bits. Blasthole drilling with diamond bits is limited in excavation work by the high bit cost, and most blastholes smaller than 3 in. (minimum size of roller bits) are drilled with percussive bits. Small-diameter diamond bits have been used extensively in the mining industry for blastholes, and therefore their possible use in civil projects should not be overlooked.

c. Drag Bits. Drag bits are designed with two or more blades as shown in Fig. 4-7. These blades are faced with sintered tungsten carbide inserts or have tungsten carbide interspersed throughout a matrix. Drag bits range in size from 1 to 26 in. and are used primarily in relatively soft rocks such as clay-shales.

d. Power Augers. Power augers are used in soft formations to speed up the removal of cuttings. The bit consists of a flat blade that continues up the shaft as a spiral. Cuttings move away from the bottom of the hole along this spiral. A wide range of hole diameters is



SOFT ROCK BIT - FOR CLAY,
SHALE, SALT, GYPSUM, CHALK,
ANHYDRITE, AND MEDIUM LIME
ROCK.



MEDIUM ROCK BIT - FOR LIME-
STONE, DOLOMITE, HARD SHALE,
AND ANHYDRITE.



HARD ROCK BIT - FOR CHERT,
QUARTZITE, DOLOMITE, AND
SILICEOUS CARBONATE ROCK.



VERY HARD ROCK BIT - FOR
CHERT, QUARTZITE, GRANITE,
AND BASALT.

Fig. 4-5. Roller bits used in quarrying rock of
different hardness⁹

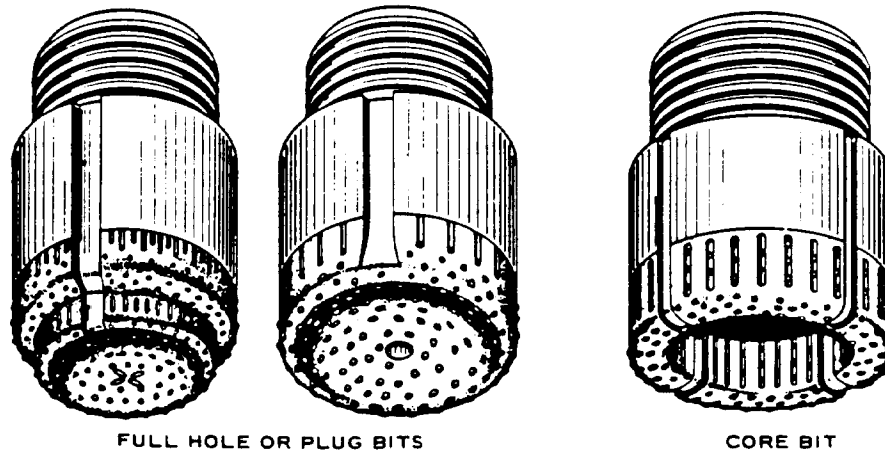

Fig. 4-6. Small-diameter diamond bits (3 in. or smaller)⁹

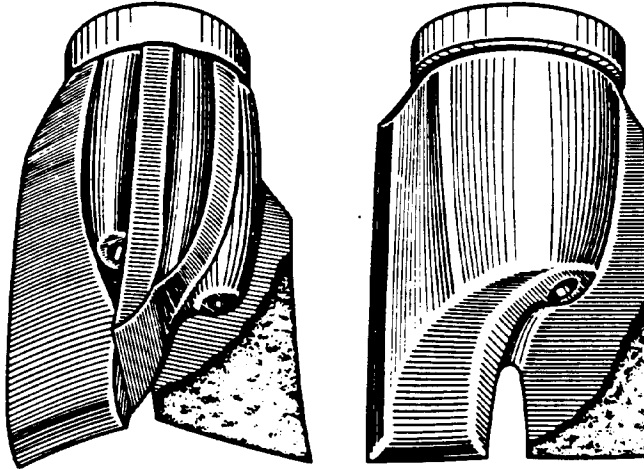

Fig. 4-7. Drag bits. Bits of this general type are available in sizes from 1-through 26-in. diameters and are used to drill soft formations⁹

available but hole depths do not usually exceed 100 ft. Although some power augers can theoretically be utilized in the same rocks as those drilled with drag bits, their principal use has been in very soft rocks or in soil.

4-4. Percussive Drills.

a. Percussive drills penetrate rock through the action of an impulsive blow through a chisel or wedge-shaped bit. Repeated application of large force of short duration crushes or fractures rock when the blow energy is of adequate magnitude. Torque, rotational speed, and thrust requirements are significantly lower for percussive systems than they are for rotary or rotary-percussive systems. Penetration rates in percussive drilling are proportional to the rate at which energy is supplied by the reciprocating piston.

b. Percussive machines include churn drills, surface hammer drills, down-the-hole hammer drills, and vibratory drills. Surface hammer drills are those in which the hammer remains at the surface. Down-the-hole drills are those in which the hammer is near the bit within the hole. They are generally used for larger holes. Vibratory drills, still in the development stage, use a mechanical, electrical, or fluid-driven transducer to deliver a high-frequency, periodic force to the bit.

c. Fig. 4-8 shows a small hammer drill. Several of the more common hammer bits and accompanying steel assemblies are shown in Figs. 4-9 and 4-10. Each bit holds replaceable tungsten carbide inserts. The bits are generally separate units detachable from drill steel. Hammer drills are capable of holes from 1-1/2 to 5 in. in diameter. Hammer drills are extensively used for blasthole drilling. The most commonly used types and their general characteristics are detailed below.

d. Jackhammers are hand-held, air- or gasoline-driven tools weighing from 37 to 57 lb. Air-driven models require between 60 and 80 cubic feet per minute (cfm) of air. Hole sizes range from 1-1/2 to 2 in., although larger drill bits are sometimes utilized in very soft rock. Jackhammers typically drill holes from 2 to 8 ft in depth and are seldom used to drill blastholes over 10 ft in depth. Stoppers and drifters are larger hammer drills and were used originally in underground excavations.

e. Wagon drills (usually mounted on rubber-tired wagons) have in the past been one of the more useful tools for rock excavations (Fig. 4-11). Today, however, they are being replaced to a considerable

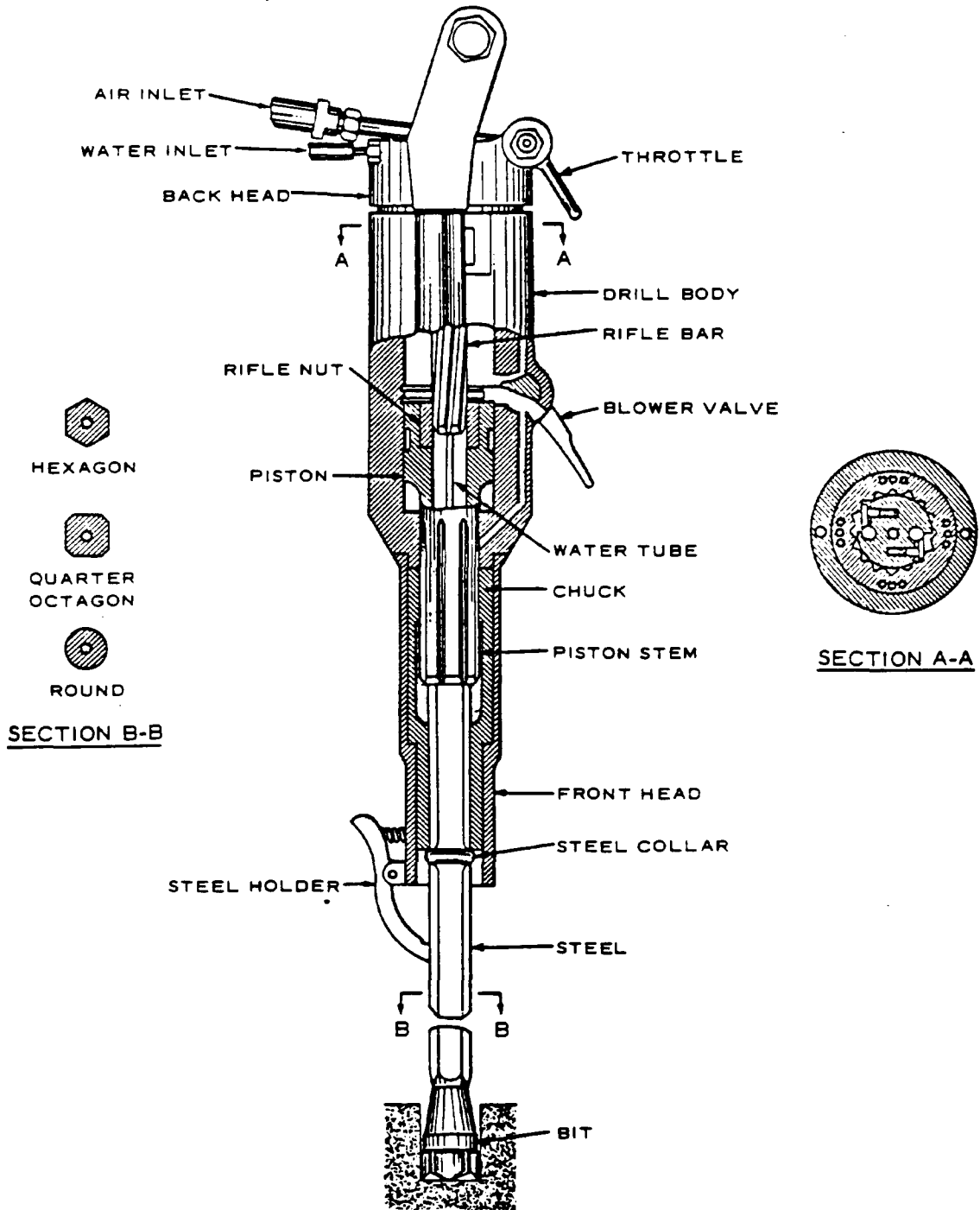

Fig. 4-8. Typical surface jackhammer drill design⁹

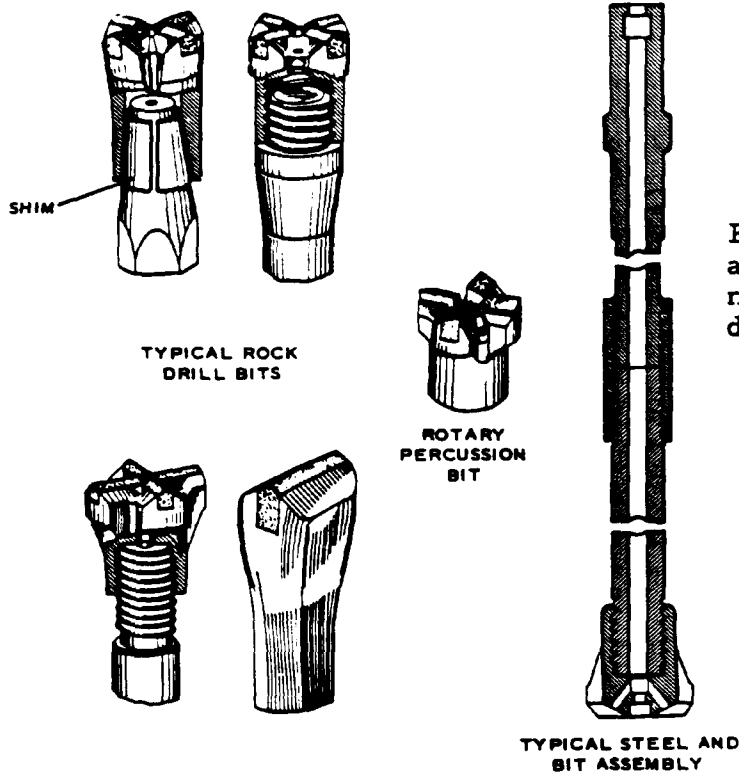
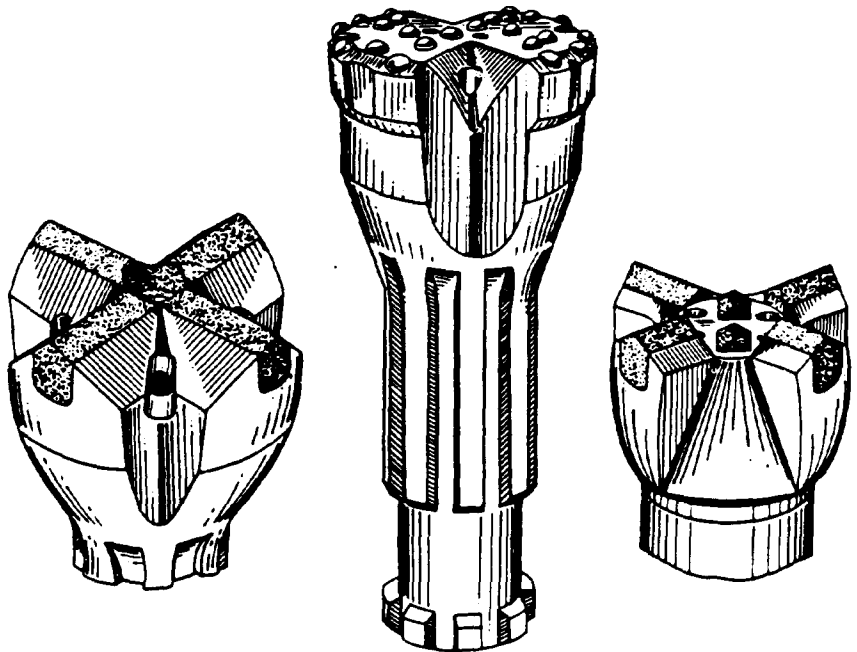

Fig. 4-9. Bits and steel assembly for surface hammer drills (figures show drive-on and threaded connections)⁹

Fig. 4-10. Bits for down-the-hole hammer drill⁹



degree by heavier crawler drills. Wagon drills utilize 1-1/4-in. drilling steel, and bits range from 1-3/4 to 3 in. in diameter. They are most effective at depths of less than 20 ft. They require between 275 and 300 cfm of air and, thus, can conveniently be paired with a 600-cfm compressor.

f. A single wagon drill can drill from 200 to 400 ft of hole in a 9-hr shift. The rate may be less in very hard rock such as granite. Considered another way, a single wagon drill can make blastholes to produce between 500 and 1,500 cu yd of rock per shift, depending on the formation properties. At this average rate a contractor would need three wagon drills to stay ahead of a 2- or 2-1/2-yd shovel.

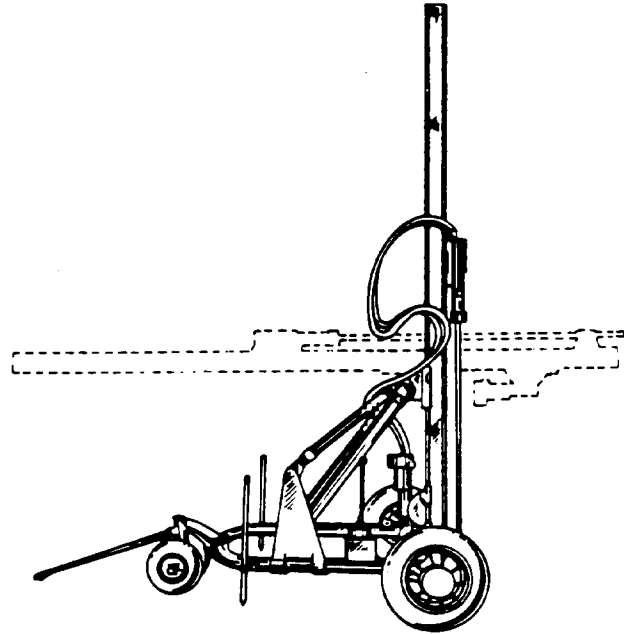

Fig. 4-11. Wagon drill⁹

g. Crawler drills (Fig. 4-12) have become widely used tools in engineering excavation and have largely replaced the wagon drill. They are heavier units capable of drilling holes between 2-1/2 and 5 in. in diameter at any angle in all types of rock. These machines require about 50 percent more air, i.e. 150 cfm more than a wagon drill for a total of 450 cfm. Hole depths of 40 ft are routine and in some cases holes 100 ft in depth are put down with heavy models. Crawler drills can produce blastholes resulting in as much as two to three times more blasted rock per shift than wagon drills.

h. The churn drill penetrates by repeatedly raising and dropping a heavy chisel-shaped bit (Fig. 4-13) and tool string at the end of a cable. The cuttings suspended in mud in the hole are periodically removed with a bailer. Churn drills are seldom used today in construction.

4-5. Rotary-Percussive Drills.

a. Rotary-percussive drills impart three actions through the drill bit. These are (a) axial thrust, of lower magnitude than in rotary drilling, (b) torque of lower magnitude than in rotary drilling but higher than

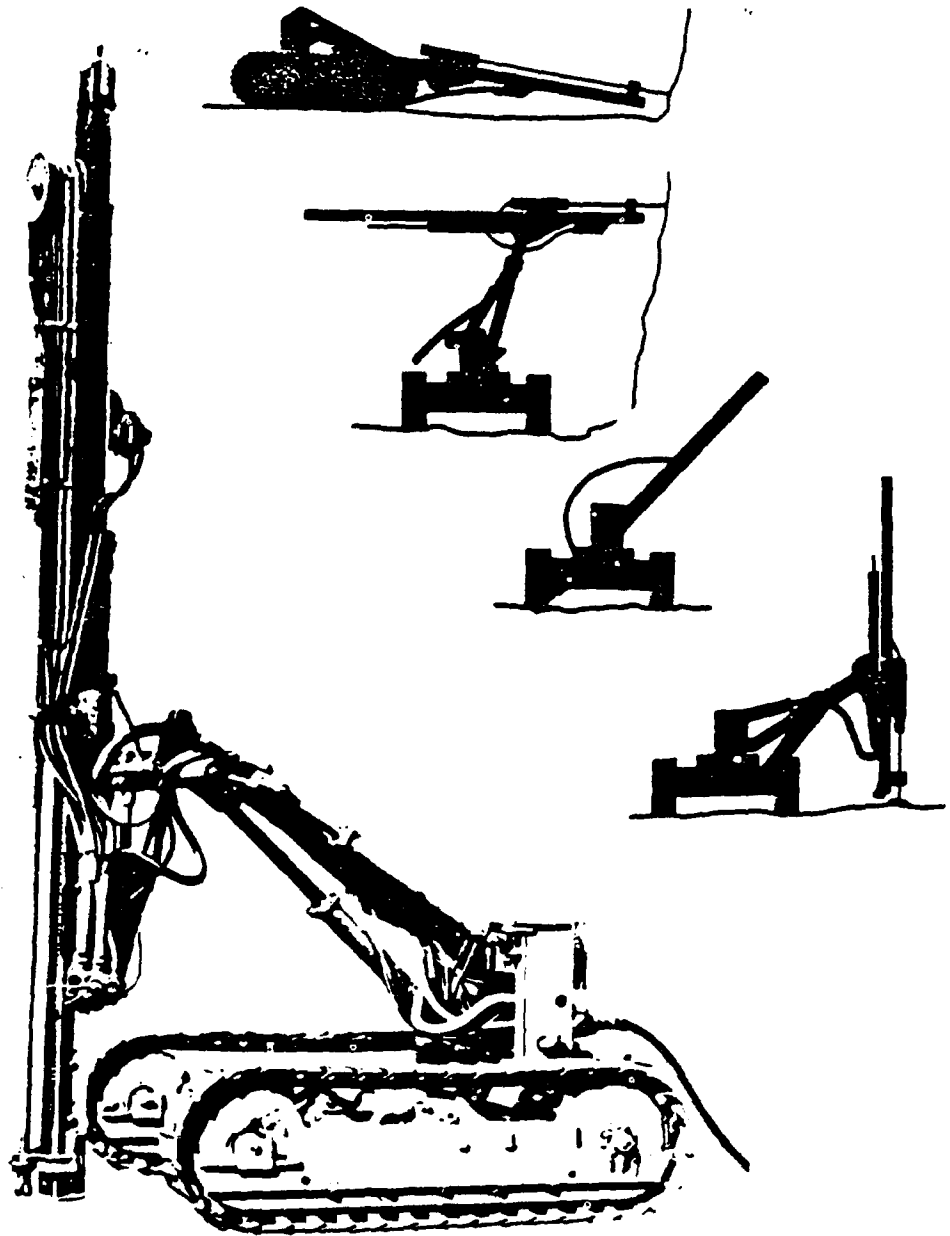

Fig. 4-12. Crawler drill capable of drilling holes from 1-3/4 to 3 in. in diameter. Insets show setup for various hole inclinations⁹

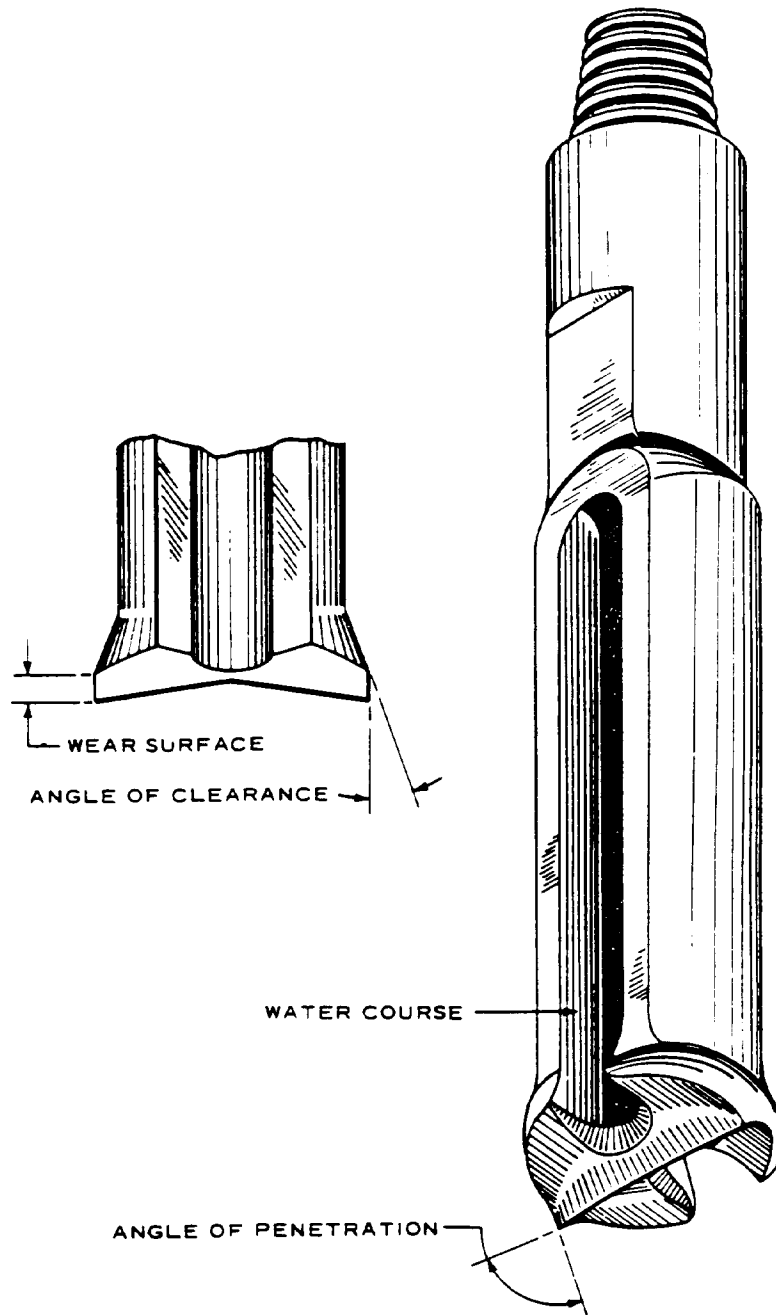

Fig. 4-13. Churn drill bit⁹

in percussive drilling, and (c) impact. Some drills have a rotation mechanism that is actuated by the impact mechanism; whereas others have a separate motor to achieve rotation. The mechanism of rock failure may be considered as a combination of the rotary and percussive mechanisms.

b. Drill bits such as those shown in Fig. 4-14 have been successfully used to drill deep blastholes from 4 to 9 in. in diameter. Conventional drill steel is used with down-the-hole drills, and since cuttings are removed up the annulus by air pressure, an air return velocity of around 50 fps is required. This velocity can be obtained with air supplies of around 15 cfm per in. of hole diameter in blastholes of moderate depth.

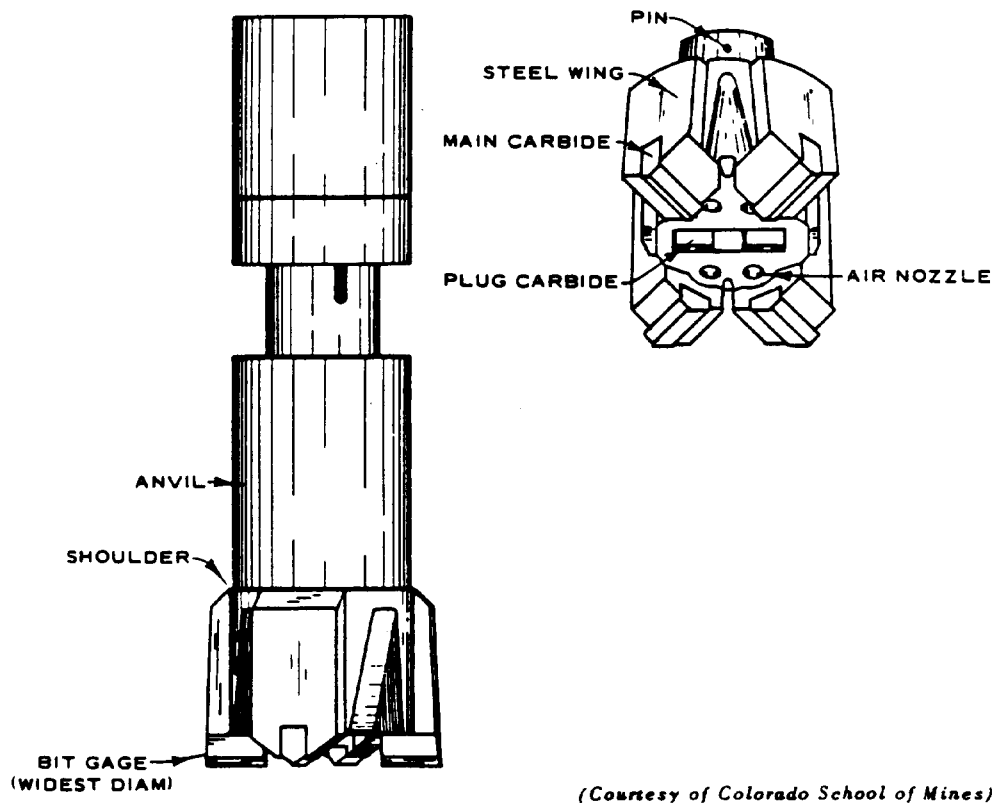

Fig. 4-14. Rotary-percussive drill bit (after Liljestrands¹³)

CHAPTER.5. BASIC SURFACE BLASTING TECHNIQUES

5-1. Introduction.

a. Rock blasting may be conducted for removal of rock, for control of excavated rock surfaces, and for control of blasted rock sizes. One project may require all types of blasting. For example, the construction of a large dam often requires removal of millions of cubic yards of overburden and rock, some of which may be wasted but much of which must be used for fill, riprap, and aggregate. Foundations, penstocks, and spillway walls should be excavated with controlled blasting to leave competent final surfaces.

b. This chapter describes preferred blasting techniques used for surface excavations. Information was obtained from CE District offices and projects supplemented in less familiar procedures by references 8 and 14.

5-2. Blasting Patterns.

a. Hole Arrays.

(1) Hole array is the arrangement of blastholes both in plan and section. The basic blasthole arrays in plan are single-row, square, rectangular, and staggered arrays (Fig. 5-1). Irregular arrays have also been used to take in irregular areas at the edge of a regular array. The term "spacing" denotes the lateral distance on centers between holes in a row. The "burden" is the distance from a single row to the face of the excavation, or between rows in the usual case where rows are fired in sequence.

(2) Blasthole arrays in profile have characteristic hole depths and inclination. Fig. 5-2 shows how this geometry can vary. Deep and shallow holes are sometimes alternated to achieve particular results. Arrays using single holes are also used (Fig. 5-3).

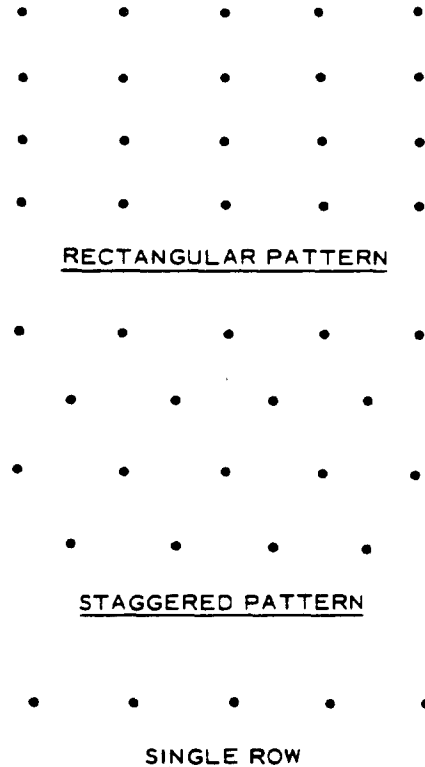

Fig. 5-1. Basic blast-hole arrays

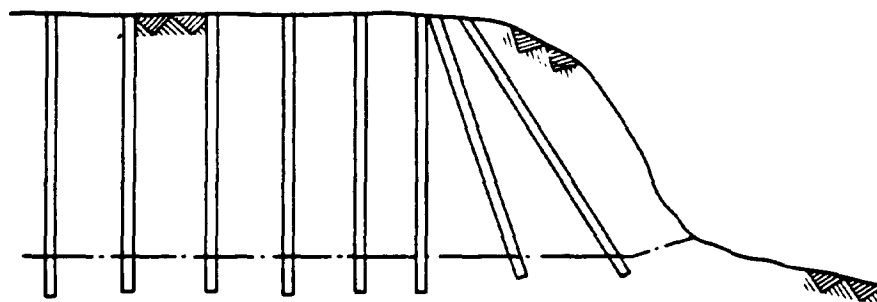
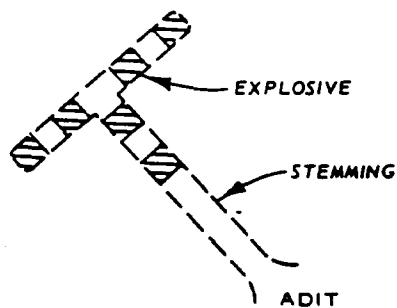
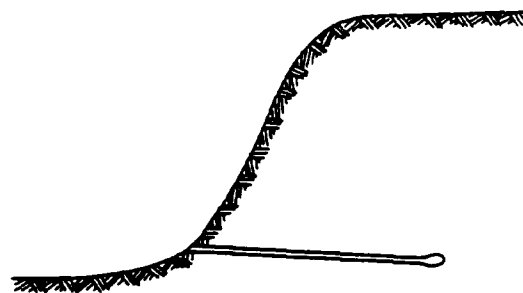

Fig. 5-2. Variation of regular arrangement of production blastholes as necessitated by topography



a. COYOTE TUNNEL (PLAN VIEW)
ALSO SEE FIG. 5-15



b. SNAKE HOLE (PROFILE VIEW)

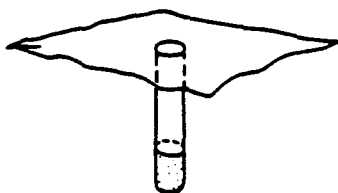

c. POINT CHARGE

Fig. 5-3. Single-hole arrays

1 Mar 72

b. Delay Patterns. The order of firing charges in a round is determined by the delay sequence, which is regulated by either a delay electric blasting cap or a delay detonating cord connector (Chapter 3). By varying delays single-row, square, and staggered patterns can be modified as an aid in achieving fragmentation, throw, rock removal, or vibration control. Fig. 5-4 illustrates some possible delay patterns.

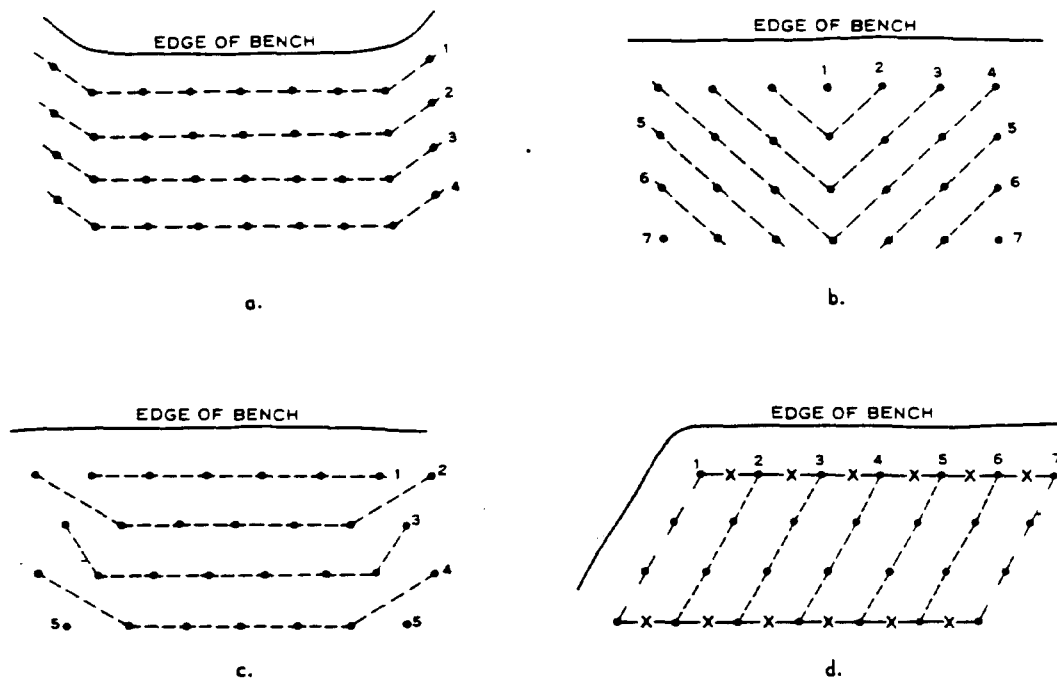

Fig. 5-4. Some possible delay patterns: a-c, with electric delays; d, with detonating cord connectors. x indicates position of detonating cord delay connector. Numbers indicate firing order

c. Arrangement of Charge in Hole.

(1) Blasting agents and explosives may be placed in the hole in solid columns or in decked columns, i.e. with segments of the charges separated by stemming. Free-running ANFO is poured into the hole on top of a primer. Additional primers are commonly placed in the column at 10- to 20-ft intervals. The charge is detonated with either electric caps inserted in each primer or with detonating cord down line tied in contact with each primer. In large holes the charge may be efficiently detonated by initiating only the bottom primer with detonating cord or blasting cap. Waterproof explosives or slurry blasting

agents must fill the wet portion of a hole before the free-running ANFO is loaded.

(2) Cartridged explosives are decked or threaded on a detonating cord down line and each cartridge is initiated by direct contact with the down line or by blasting caps. Presplit charges (para 5-4a) are string loaded or joined continuously in special long cartridges.

(3) Powder factor is the widely used term for the pounds of explosive necessary to blast a cubic yard (or ton) of rock. This simple ratio provides an approximation of the relative size of the charge in a hole or those in a round.

5-3. General Rock Removal.

a. Bench Blasting. The most common method of production blasting in quarrying and construction excavation is bench blasting. It involves inclined, vertical, or horizontal blastholes drilled in single- or multiple-row patterns to depths ranging from a few feet to 100 ft or more depending on the desired bench height. Where the excavation is shallow, i.e. less than about 20 ft in height, one level may suffice. In deep excavations, a series of low benches, offset from level to level, are recommended for operational convenience. Bench height is often two to five times the burden and the ratio of burden to spacing is often 1:1.25 to 1:2.0.

(1) Spacing and Burden.

(a) High quarry benches are usually blasted with large-diameter charges and large hole spacing. The rectangular array, with spacing between the holes greater than the burden, is considered most effective here. Common patterns for 5- to 6-1/2-in. holes in limestone are 14 by 20 ft (burden versus spacing) for 30- to 50-ft faces, and 16 by 24 ft for 50- to 70-ft faces.

(b) Lower benches, up to 40 ft, are commonly drilled with small-diameter holes (up to 4 in.), on a staggered or square delay pattern, from 6 by 6 ft to 12 by 12 ft. Narrow low benches are often blasted in a rectangular array of 4 by 10 ft to 6 by 9 ft depending on the rock type, borehole diameter, and explosive density.

(c) Some blasters use a rule of thumb that the burden should be between 20 and 40 times the drill-hole diameter.

(d) Another method of developing side and through cuts and benches is the trapezoidal array¹⁵ in which holes fan out from bottom

to top toward the sides of the cut (Fig. 5-5). This narrowing at the bottom gives an advantageous concentration of explosives at the toe. A disadvantage of this method is that the direction of each hole in a row is different and difficult to obtain.

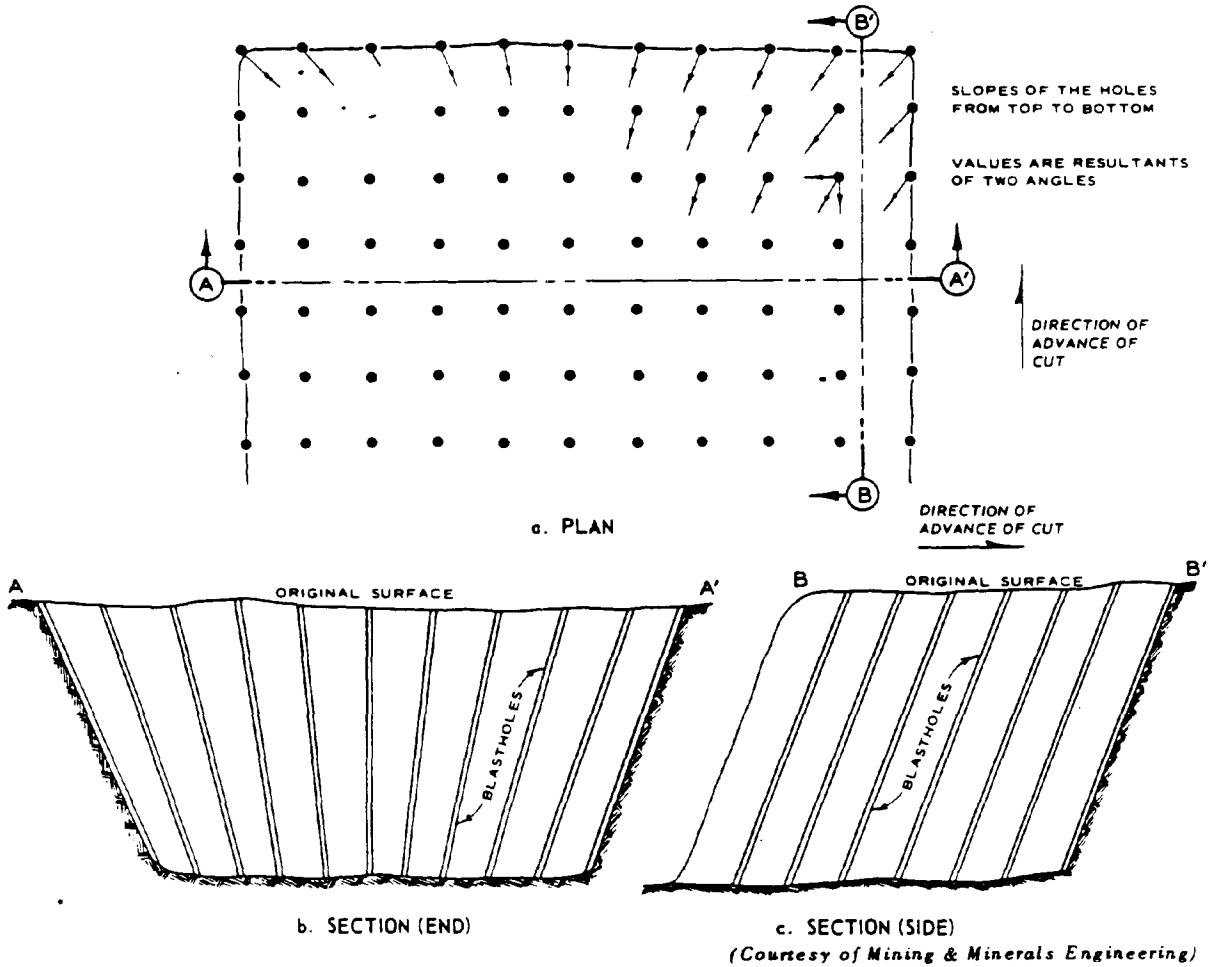

Fig. 5-5. Trapezoidal blasting pattern (after Babic¹⁵)

(2) Advantages of Inclined Blastholes. Most bench blastholes are drilled vertically. However, blastholes inclined as low as 45 deg and paralleling the free face apparently use blast energy more effectively. Fig. 5-6 indicates the region of reflected tension waves is larger in inclined holes. Greater reflected blast energy results in more efficient fragmenting of the rock. In addition, the sloping bench face allows better displacement of the muck pile. Angles more than 30 deg from vertical are seldom used because of excessive drill bit wear and

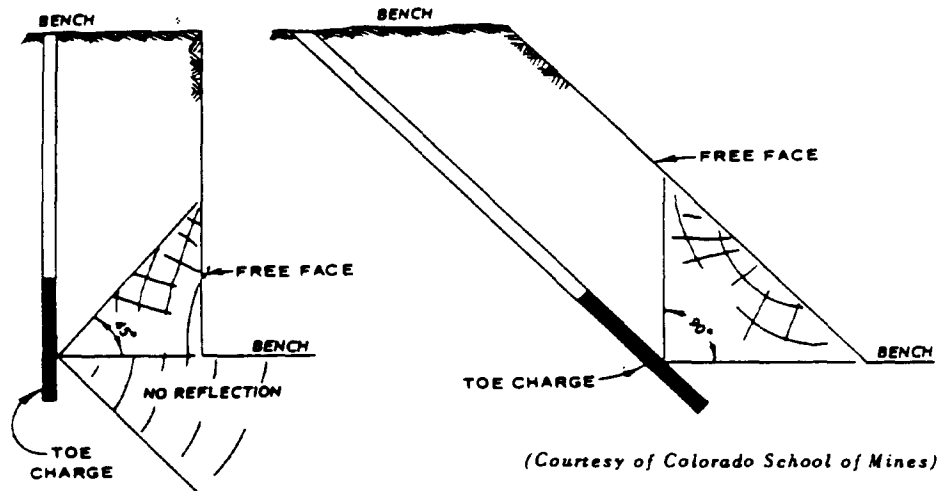

Fig. 5-6. Shock-wave propagation through rock generated by detonation of toe charge (after Kochanowsky¹⁶)

difficulty in loading. Although further testing on use of inclined holes is necessary, the following advantages have been proposed:

(a) Increase in burden with depth is avoided (assuming bench face is not vertical).

(b) Loading factor may be reduced because of reduced resistance at the toe.

(c) Angle of breakage at the bottom is greater, making it easier to break and loosen the rock (Fig. 5-6).

(d) Previous muck piles are removed easily because of more freedom of movement (Fig. 5-7).

Despite their advantages inclined drill holes are more difficult to align properly from an irregular ground surface.

(3) Lifters and Snake Holes. Rough terrain or loose overburden may prohibit drilling the bench from the top. In such cases lifters, nearly horizontal blasthole charges, may be used instead. Snake holes are similar to lifters except that they are always located at the toe of the slope. They should be inclined slightly downward (Fig. 5-8). They may also be supplemented above with rows of lifters inclined 20 to 30 deg upward from horizontal. The pattern is commonly fired in

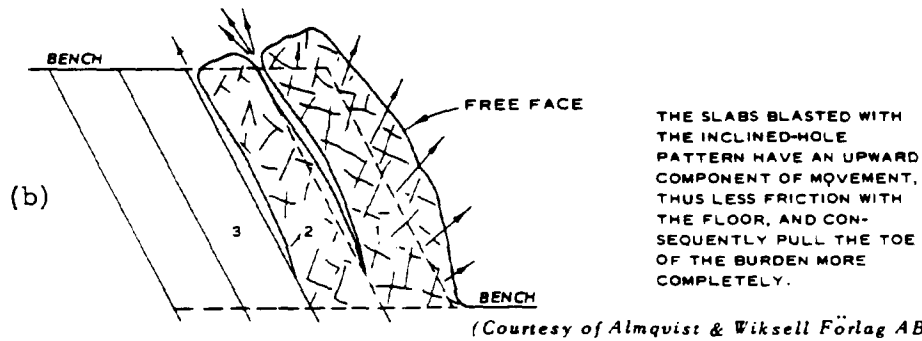
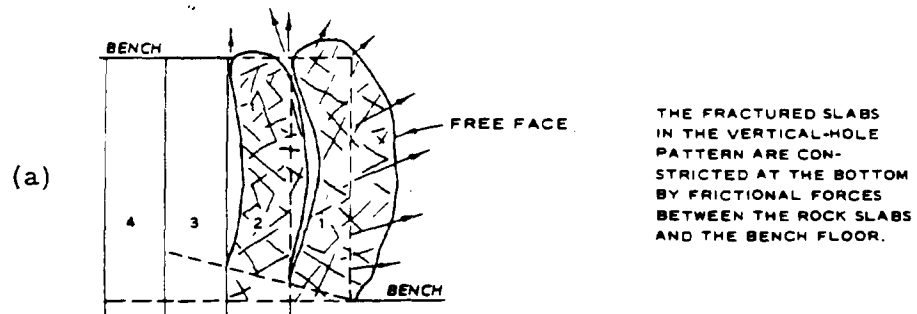

Fig. 5-7. Bench-slab movement during blast with vertical (a) and inclined (b) holes (after Langefors and Kihlström¹⁴)

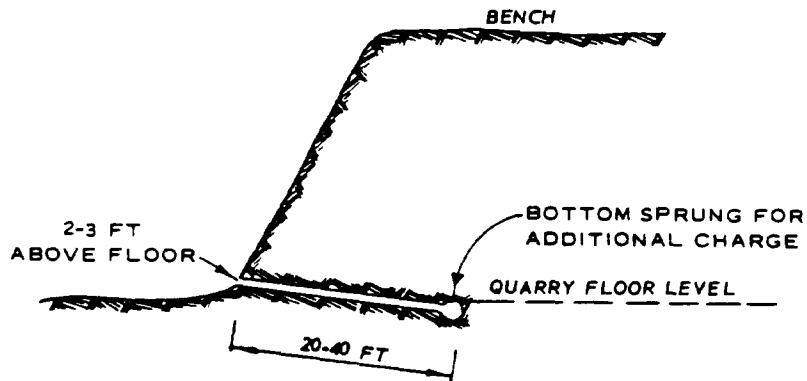

Fig. 5-8. Typical placement of snake hole

sequence, starting at the top. High quarry faces (75 ft and more) have been successfully blasted using a combination of snake holes and vertical holes. Lifters and snake holes are not commonly employed in structural excavation as their use generally requires that previously blasted rock be excavated before drilling can commence for subsequent rounds. Snake holes may produce excessive flyrock, and if they are drilled on an incline to below the final grade-line tolerance, the final rock surface is damaged.

(4) Varying the Hole Array to Fit Natural and Excavation Topography.

(a) Benches may be designed and carried forth with more than one face so that simple blasting patterns can be used to remove the rock. Fig. 5-9 shows a typical bench cut to two free faces and fired with one delay per row. The direction of throw of the blasted rock can be controlled by varying the delay pattern (Fig. 5-9a). The rock will

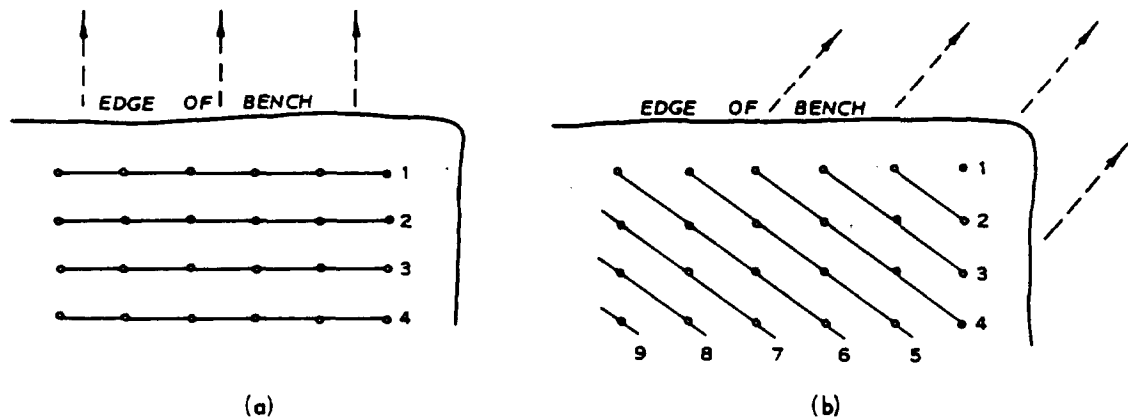
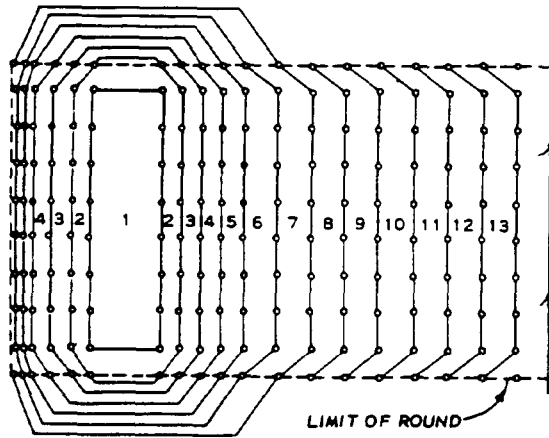
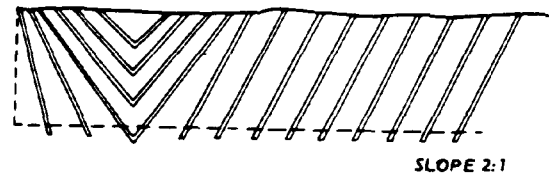

Fig. 5-9. Varying the direction of throw (arrows) by arrangement of delays (numbers)

move forward normal to the rows of holes. If the holes were fired in oblique rows (Fig. 5-9b) from right to left, however, the rock mass would be thrown to the right during blasting.

(b) The relations of delay systems to the drill-hole pattern should be considered an integral part of the blast pattern. Because of the change in direction of free faces toward which the rows will fire, the burden is decreased and spacing increased and the pattern is changed from square to staggered.

(c) Excavations can be opened by plow or deep "V" cuts where an initial cut is lacking. The cut is then enlarged in one of several bench levels. Fig. 5-10 shows a multiple-row round designed to open an excavation such as a foundation, wide bench, or road cut. Fig. 5-11 shows an elongated quarry blast pattern opened in the center and progressing toward each end by means of delays. This method may be used in deep through cuts 100 to 300 ft wide at the top. Where the cut becomes narrow, it may be worked from the center row outward toward the sides, as shown in Fig. 5-12.



(Courtesy of Almqvist & Wiksell Förlag AB)

Fig. 5-10. Multiple-row round including a V-cut opening. Rock in delay areas 1-4 is removed first to establish the free face (after Langefors and Kihlström¹⁴)

(d) The depth of each lift or bench is usually about 10 to 30 ft with shallower depths considerably more efficient. With large or inclined holes the benches may be 50 ft or more in height but this should not be considered in structural excavation. Bench heights in cuts through hilly topography change continuously and burden and spacing must be modified accordingly. In Fig. 5-13 all holes bottom near the lower limit of intended breakage, but spacing, burden, and hole depth increase uphill to comply with the irregular ground surface.

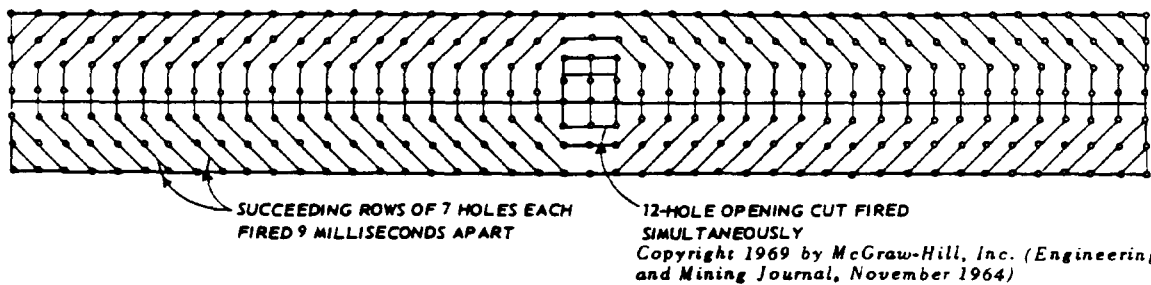

Fig. 5-11. Large quarry blast pattern measuring 600 by 100 by 48 ft. Illustrates how a single round accomplished what normally was done in 15 shots¹⁷

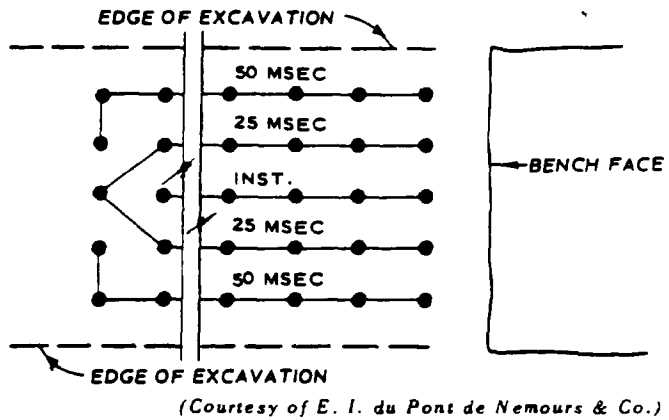
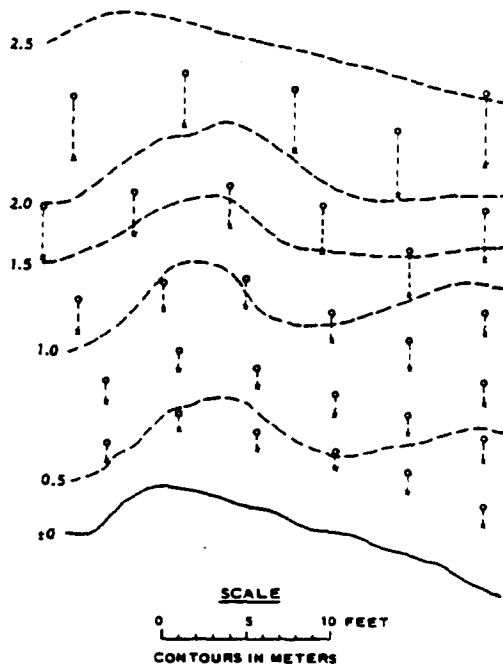

Fig. 5-12. Delays, in milliseconds, as shown (Du Pont⁸)



- NOTE:
- THE POSITION OF THE HOLE AT THE INTENDED BOTTOM OF BREAKAGE
 - THE COLLARING OF THE HOLE ON THE ROCK SURFACE

(Courtesy of Almquist & Wiksell Förlag AB)

Fig. 5-13. Distribution of inclined holes for a road cut in uneven topography. Regular hole array distorted to fit topography (modified from Langefors and Kihlström¹⁴)

1 Mar 72

(5) Charge Distribution.

(a) Rounds in bench blasting should contain an optimum distribution and weight of explosive. The bottom few feet of the hole is usually loaded heavily with a dense, high-velocity explosive such as gelatin dynamite in order to pull the toe. The amount can be decreased if inclined holes are used.

(b) In dry holes, where a waterproof explosive is not necessary, free-running blasting agents can be used for the entire charge column if primed heavily at the bottom with a dense, high-velocity explosive.

(c) Table 5-1 gives charge concentrations for various hole diameters in bench blasting. Fig. 5-14 illustrates the loading of a typical inclined bench hole. The interval above the charge reduces excessive shatter of rock at the top¹⁸ and normally can be decreased in smaller diameter holes. It is stemmed to retain gases and reduce noise and flyrock.

Table 5-1. Charge Concentration of Inclined Holes⁽¹⁾ for Single-Row Bench Blasting for Fragmentation with Respect to Various Burdens and Hole Diameters (Modified from Langefors and Kihlström¹⁴)

(Courtesy of Almqvist & Wiksell Förlag AB)

| Hole Diameter in. | Concentration of Bottom Charge lb/ft | Concentration of Column Charge lb/ft | Total Bot- tom Charge lb | Max Burden ft |
|----------------------|--|--|--------------------------------|---------------------|
| 1 | 0.42 | 0.17 | 2.1 | 3.8 |
| 2 | 1.7 | 0.7 | 17 | 7.8 |
| 3 | 3.8 | 1.5 | 57 | 11.5 |
| 4 | 6.7 | 2.7 | 130 | 15.5 |
| 5 | 10.5 | 4 | 260 | 19.5 |
| 6 | 15 | 6 | 440 | 23 |
| 7 | 20 | 8 | 700 | 27 |
| 8 | 27 | 11 | 1,100 | 31 |
| 9 | 34 | 13 | 1,500 | 35 |

Note: Values are only for an explosive with relative strength value = 1 corresponding to 35 percent nitroglycerin dynamite; relative strength of blasting gelatin = 1.27 and ANFO = 0.87.

(1) Slope is 2 to 3 vertical to 1 horizontal.

(6) Subdrilling. Blastholes are usually subdrilled where damage

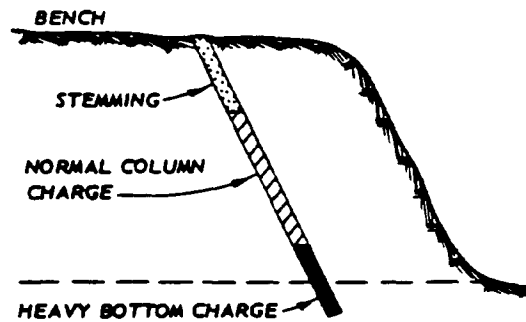

Fig. 5-14. Charge distribution in bench blasting. (See Table 5-1 for typical charge weights)

to the underlying rock is of no concern, and where no natural surface is available for horizontal control.¹⁸ Depth below intended bottom may be 0.2 to 0.3 times burden to assure that the desired depth is reached. Inclined blastholes require less subdrilling to pull all the rock to bottom than do vertical holes (a(2) above). Because of the commonness of stress concentrations and consequent stability problems near the toe of the slope, overshooting there should be avoided.

(7) Secondary Blasting. Bench blasting ideally reduces all rock to a desired rubble size range. This is basic in order to facilitate handling of rubble, to meet limitations imposed by equipment, e.g., bucket size, or to produce a usable material. Actually, even a satisfactory blast may leave a few oversize blocks that must be broken by secondary blasting (pop blasting) or other means. Large blocks may be broken by blasting with light charges placed in small drill holes in the block. A quick method for smaller blocks, known as mudcapping, involves blasting with a part of a stick of powder placed against the block and covered with mud or a bag of sand. Light shaped charges are effective in block breakage also. Mudcapping and shaped charges may produce objectionable airblast, and breakage with a drop ball is preferred wherever that equipment is adequate and available.

b. Coyote Blasting, Trenching, and Cratering.

(1) Coyote blasting (gopher hole or tunnel blasting) is the practice of firing large charges of explosives placed in tunnels driven into a rock face at floor level. It is used where large quantities of material are to be removed cheaply. Coyote blasting works best in faces 75 to 175 ft high when using one level of tunnels. Higher banks can be blasted if the tunnels are supplemented with large blastholes to about one-third the depth of the face.

1 Mar 72

(2) A basic coyote layout consists of a main adit driven perpendicular to the face with wing tunnels driven left and right at 90 deg. The total round in the tunnels is split and placed in pits or on the floor commonly at 20- to 25-ft spacings. Fig. 5-15 shows a coyote layout with detonating cord tie-ins ready for detonation. The main tunnel should be stemmed completely with rock and other suitable material. Charges in the wings should also be stemmed, particularly where seams and partings are encountered or the burden varies greatly.

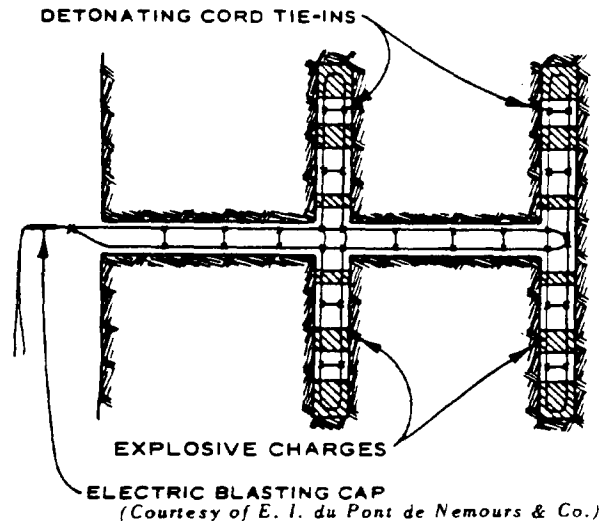

Fig. 5-15. Plan of coyote layout with detonating cord (after Du Pont⁸)

(3) The loading varies with the tunnel layout and local depth. In general, the deeper the tunnel, the larger the charge. Current coyote blasting is done with bagged ANFO prills or dynamite. A review of large coyote blasting may help guide design of smaller, more routine coyote blasts; for example see reference 19.

(4) Trenching steep-sided cuts through rock may be a useful blasting technique for culverts, pipelines, etc. The blasting only loosens material for subsequent removal mechanically. An initial blast of one or two holes creates a crater toward which succeeding delayed charges move the material. A single row of holes is used for narrow trenches; two staggered rows are recommended for trenches up to 5 ft wide; and trenches greater than 5 ft wide require additional rows of holes. Shallow trenches are commonly subdrilled 1 to 1-1/2 ft. Deep trenches should be blasted in lifts of 4 to 5 ft.

(5) Cratering, the technique in which large point charges will be used to excavate pits, quarries, and throughcuts, holds promise for the future. It is still largely in the developmental stage but at least one major canal in rock and soil has been excavated in this manner.²⁰

c. Underwater Blasting. Blasting submerged rock is more difficult for the following reasons: confining pressure (hydrostatic) is high; holes are difficult to load after being drilled; vibration effects are more pronounced in water; most of the area cannot be observed and checked visually.

(1) Underwater Surface Shooting. Where hard rock overlies softer rock at shallow depth or only a few feet of soft material is to be removed, the "adobe" or underwater surface blasting technique may be used. Usually 50-lb charges of high-velocity, waterproof explosives such as 60 percent gelatin dynamite or slurry blasting agents, are placed on the surface of the rock in a regular pattern connected with detonating cord for simultaneous detonation. At least 25 ft of water is needed for confinement in some jobs but this will vary.

(2) Underwater Blasting in Drill Holes. Underwater blastholes are usually drilled from a barge. Hole diameters usually range from 2-1/2 to 6 in. depending on rock type and depth of cut. To insure proper depth of cut, blastholes are often drilled to the same depth below grade as the spacing between the holes. A commonly used depth below grade and hole spacing is 10 ft. A higher powder factor is usually required for underwater blasting. A square pattern of blastholes, with the same volume of rock per hole as an extended pattern (Fig. 5-16(a) and (b)), assures breakage of the rock by succeeding

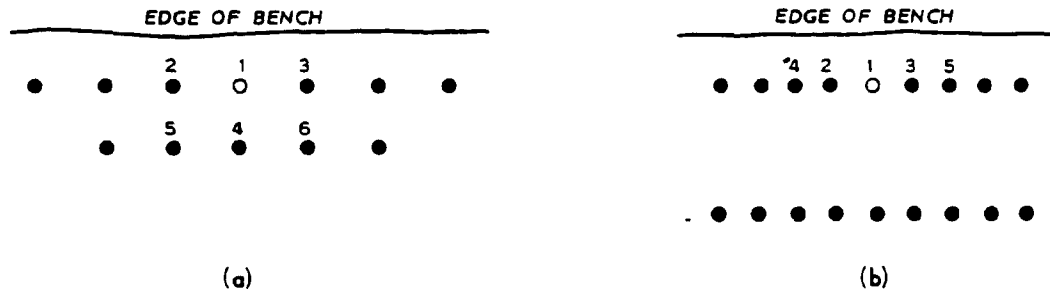

SQUARE PATTERN. HOLE 1, DEFECTIVE, IS MISSED BY 2 AND 3 BUT BLASTED BY 4, 5, AND 6. FOR LARGE BURDEN AND BENCH HEIGHT.

EXTENDED PATTERN. HOLE 1, DEFECTIVE, MAY BE TAKEN OUT BY 2, 3, 4, AND 5, BUT WILL BE UNAFFECTED BY THE SECOND ROW OF HOLES. GOOD FOR LOW BENCHES.

(Courtesy of Almqvist & Wiksell Forlag AB)

Fig. 5-16. Blasthole patterns for underwater blasting (after Langefors and Kihlström¹⁴)

rows of holes even if a defective hole fails to fire in the front row, provided the holes are drilled to a sufficient depth below grade and charged heavily enough to pull the added burden of the unfired hole.

5-4. Excavation for Control of Rock Surfaces. Overbreakage and

fracturing from excavation blasting often necessitate the removal (scaling) of loose material beyond the designed face and placement of an additional amount of concrete. In addition, blast damage to the final rock face may cause instability and rockfall hazards. For these reasons, among others, controlled blasting is indispensably routine in excavation for structures and elsewhere. Controlled-blasting techniques minimize overbreakage and permit steeper slope designs because of increased mechanical stability and resistance to weathering. They also reduce deeper fracturing and weakening of the finished excavation. The techniques can be used to cut an excavation to accurate lines and around vertical and horizontal corners. Improved appearance of rock slopes may also result. Three controlled-blasting techniques in use today are presplitting (Fig. 5-17), smooth blasting, and line drilling.

a. Presplitting. A presplit surface is initiated along the excavation line by blasting instantaneously a single row of closely spaced drill holes prior to detonating the main rounds. The presplit surface reduces enough of the blast effects of the main round to reduce damage in the rock beyond it. Ideally a single fracture connects adjacent blastholes (Fig. 5-18), and half of the hole (cast) remains at each presplit hole. Excessive crushing and radial cracking at the periphery or between holes are indications that the charges should be reduced. Supplemental adjustment of hole spacing may also be necessary. Formation of the presplit fracture is influenced by borehole spacing, with the closer spacing forming a more prominent fracture. Because of the high cost of drilling, the optimum spacing is the largest at which radial cracks will join and form a continuous undamaged surface.

(1) Design of the Presplitting Layout.

(a) Critical factors in successful presplitting, other than excavation slope design, are hole diameter and spacing, hole deviation, charge distribution, and confinement. Preblast field testing may help to determine optima for each job. Competent and homogeneous rock usually permits greater spacing, while the hole diameter is usually smaller in hard rock than in soft (para 6-2). Presplitting holes usually are double loaded at the bottom to insure splitting to the full depth, but some blasters question the value of heavier bottom loads.

(b) Review of data from 35 successful presplitting operations indicates that a spacing of 24 in., center to center, and a hole diameter of 3 in. were used most often (Table 5-2). Charges were usually 1-1/4- by 4-in. half-cartridges of 40 percent gelatin or ammonia gelatin dynamite taped at 1-ft intervals (intervals as much as 3 ft have been used) to down lines of detonating cord with one or two 1-1/4- or 1-1/2- by 8-in. sticks at the bottom. This amounts to about 1/4 lb

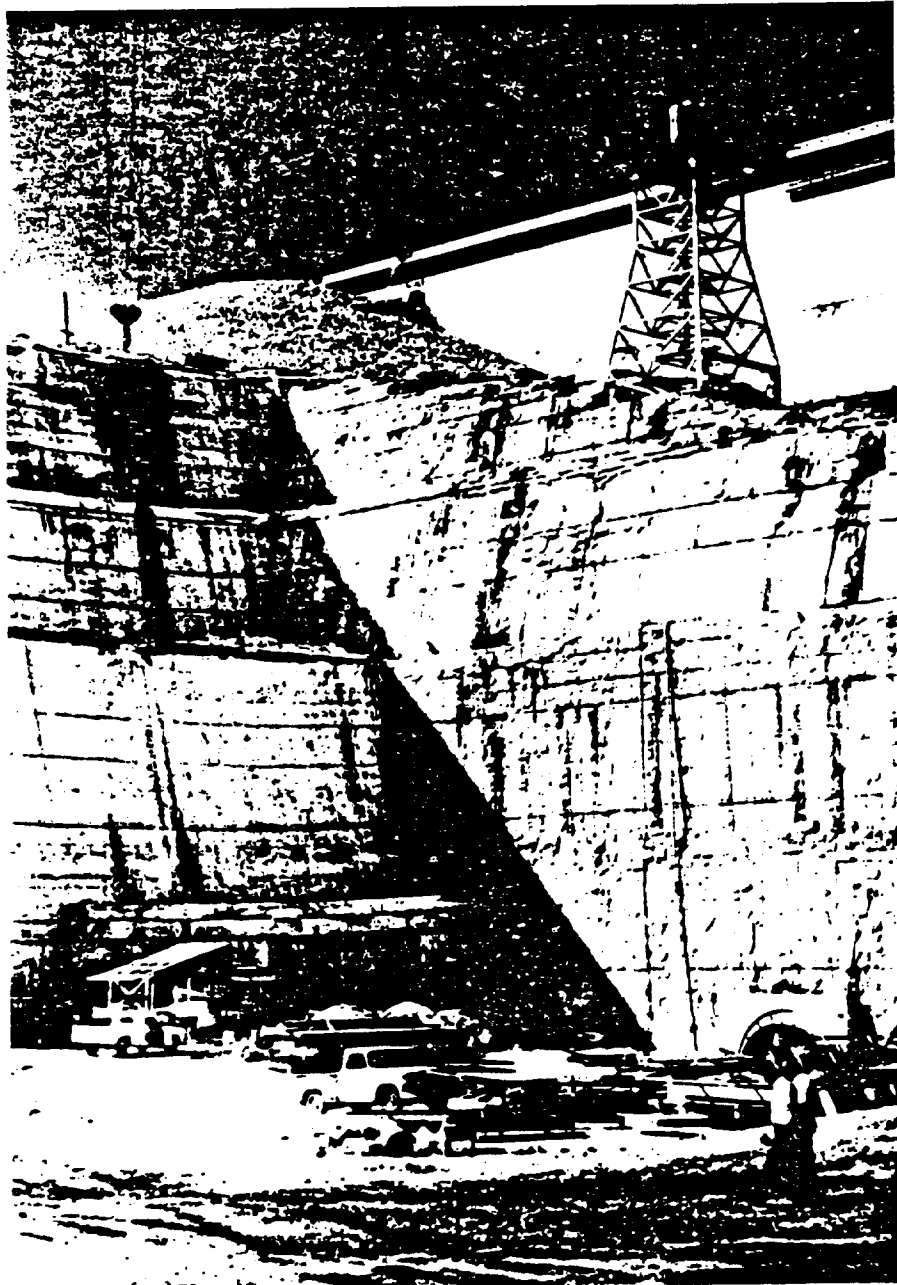

Fig. 5-17. Presplit blasting in limestone
for a powerhouse

1 Mar 72



Fig. 5-18. Presplit fracture

Table 5-2. Most Commonly Used Presplitting Arrangements⁽¹⁾ (Results of 35 Sample Analyses)

| | Hole Spacing in. | Hole Diameter in. | Charge ⁽²⁾ | Explosive |
|-------|---------------------|----------------------|--|--|
| Mode | 24 | 3 | 1-1/4- by 4-in. sticks at 12-in. intervals | 40 percent gelatin or ammonia (extra) gela- tin dynamite |
| Range | 16-48 | 2.5-4.5 | -- | -- |

(1) Hole spacing will be less for lifts of less than 6 ft.

(2) Although 1-1/4- by 4-in. sticks have been used commonly in the past, long narrow cartridges are becoming prevalent (see text) in current use.

EM 1110-2-3800
1 Mar 72

of dynamite per foot of hole; however, lighter loads would probably be better in weak rock masses. Stemming consisting of 3/8-in. clean stone chips or fine gravel should be poured around the charges and should fill the top 3 to 4 ft of hole. Fig. 5-19 illustrates presplit blast-holes loaded and ready for firing. The detonating cord down lines from each hole are tied to a trunk line. The trunk line leads at each end to electric blasting caps.²¹

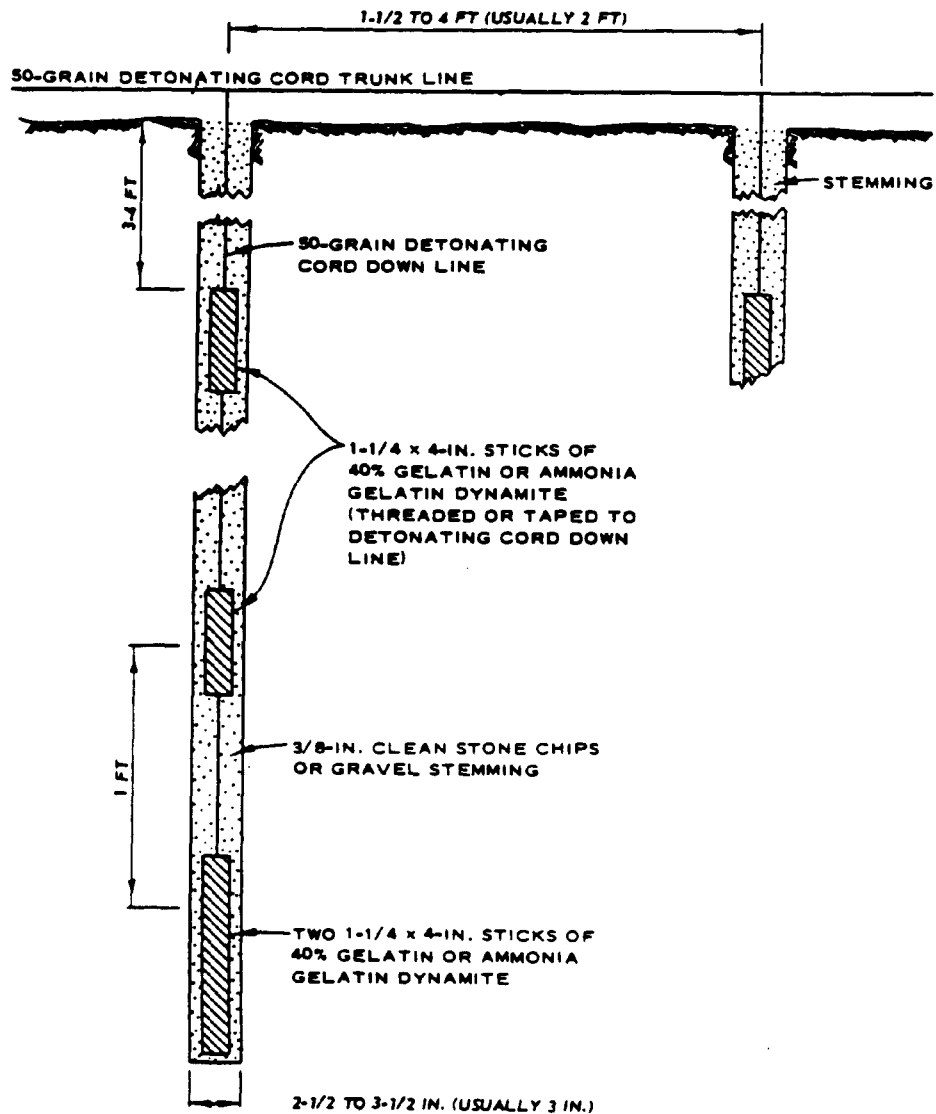

Fig. 5-19. Section of typical presplit holes ready for firing

1 Mar 72

(c) Explosives packaged in cardboard tubes that can be coupled into a continuous column as they are placed in the hole can be used in place of the string loads. Such long narrow cartridges (i.e. 1 by 36 in. and 3/4 by 24 in.) are becoming prevalent in current practice. They give better powder distribution and lessen the chances of crushing rock at the perimeter of the borehole. Loading time is also reduced considerably and contractors should be encouraged to use them.

(d) Hole depth in presplitting is limited by the difficulty in drilling accurately aligned holes which, in turn, is dependent on the quality of the rock mass. When more than one level of presplitting is necessary, a 1-ft bench offset is usually left between lifts by the drill setup. Presplit holes are commonly 25 to 40 ft deep. Holes exceeding 40 ft should not be permitted unless it can be demonstrated that accurately aligned holes will be achieved. It is essential that the holes start and remain in the presplit plane; therefore care must be exercised, first, in establishing the trace of the plane on irregular ground surfaces and, second, in maintaining the correct inclination and direction of the holes. Templates are often useful in achieving correct drill setups.

(e) Presplit blastholes loaded with gelatin dynamite can be either wet or dry. Wet holes tend to increase occurrences of bridging of stemming material such as drill cutting, overburden, or clay. Only clean stone chips or screened gravel should be used. Either angled or vertical holes may be used, as long as they are kept parallel by using a clinometer. The deviation of holes from the designed plane should not be greater than 6 in. at the bottom and for close hole spacing should be much less.

(2) Relation to Main Blast. Presplitting and primary blasting are sometimes performed in one operation with the presplit and primary holes drilled and loaded at the same time. Delays of 100 to 200 msec separate the two blasts. This method reduces time needed to set up drilling equipment. Usually, however, the line of presplit holes is drilled ahead of the main blast pattern as shown in Fig. 5-20. The final row in the primary pattern is commonly kept 3 to 4 ft from the presplit row. A delay pattern designed to provide maximum relief to the main blastholes nearest the presplit line should be used for the primary blasting. Delays sequenced parallel to the presplit may reduce damage in the permanent wall (see d(3)(c) below). The presplit surface should be kept about half the length of the primary pattern ahead of the main blast area so that subsequent blasts can be altered to fit changing rock conditions. Lighter loading of holes of the main charge near the presplit may reduce damage to the wall (d below). In special cases where the confinement (burden) is not sufficient, smooth blasting may be applicable (b below).

1 Mar 72

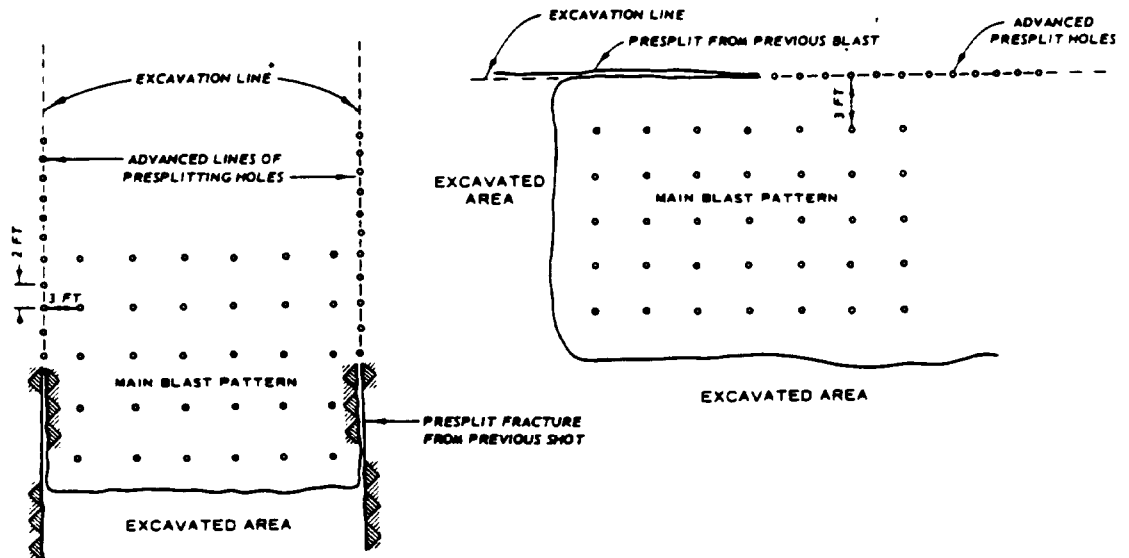

a. PLAN OF TYPICAL THROUGH-CUT PATTERN

b. PLAN OF TYPICAL SIDE-CUT OR BENCH BLASTING PATTERN

(Courtesy of Pacific Builder & Engineer)

Fig. 5-20. Relation of presplit to main pattern (after Veith²²)

(3) Presplitting Horizontal and Vertical Corners. Presplitting corners is a major problem. Battering is not always acceptable and right angles are required. On inside corners the presplit fracture often propagates into the adjacent wall, and on outside corners the right angle is difficult to attain and preserve. One method involves placing one of the loaded holes at the corner. Another method utilizes unloaded guide holes at one-half spacing, in place of loaded holes (Fig. 5-21) in the vicinity of the corner, but some CE and Bureau of Mines personnel feel that such guide holes have little value. Some CE project specifications require line drilling (c below) at the corners.

(4) Horizontal Presplitting. Presplit holes may be carried into a steep face to form a horizontal fracture above the existing floor.²³ Normal vertical holes may break below the required grade, so a horizontal row of holes, about 3 in. in diameter and spaced about 24 in. apart may be preferred. Horizontal presplitting and subsequent excavation blasting form an acceptable bench at the desired level. The technique should be considered in grade excavation along a rock cliff where it is particularly important to preserve the edge and avoid excessive fill downslope.

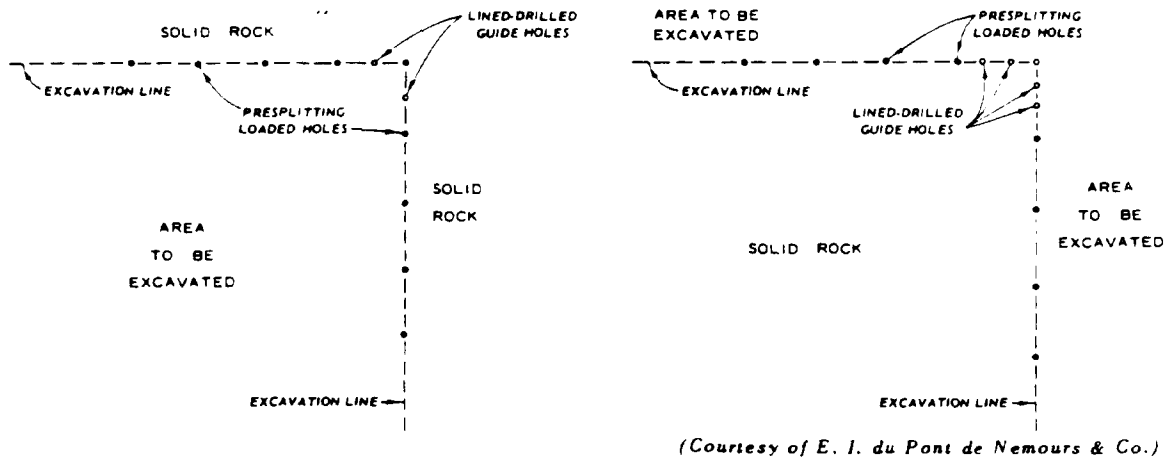

Fig. 5-21. Use of guide holes in presplitting inside and outside corners (after Du Pont⁸)

b. Smooth Blasting.

(1) In smooth blasting a narrow berm is left to reduce damage to the final wall by the main blast. This berm is subsequently removed by firing small or lightly charged holes along the neat excavation line. Smooth blasting may also be used for trimming natural slopes to grade in the special case where burden is low. The technique should not be regarded as a substitute for presplitting. Cushion blasting is a special case of smooth blasting in which considerable air space or stemming surrounds charges in the holes and serves to reduce undesired blast effects in the final wall. Hole spacing for smooth blasting should always be less than the width of berm (burden) being removed (Table 5-3). Charges, commonly 8-in. cartridges of dynamite, are string-loaded 1 to 2 ft apart on detonating cord down line or placed in the hole through loading tubes. The space between and around charges and the top few feet of hole are stemmed. A bottom charge two or three times that of the others should be used to insure splitting there.

(2) The depth of blastholes is limited by drilling accuracy. Deviation at the bottom should not exceed 6 in. Holes as deep as 90 ft have been drilled, but normally excavations over 60 ft in depth are blasted in two lifts or more.

c. Line Drilling and Close Drilling.

(a) Line drilling consists of placing a row of unloaded drill holes along the excavation line spaced on centers no more than two times the

Table 5-3. Some Typical Hole Spacings and Diameters, Charge Concentrations, and Burdens for Smooth Blasting (after Langefors and Kihlström¹⁴)

| Drill Hole Diameter in. | Charge Concentration lb/ft | Spacing ft | Burden (thickness of berm) ft |
|----------------------------|-------------------------------|---------------|----------------------------------|
| 1-1/2 | 0.08 | 2 | 3 |
| 2 | 0.17 | 2-1/2 | 3-1/2 |
| 2-1/2 | 0.23 | 3-1/2 | 4-1/2 |
| 3 | 0.34 | 4 | 5-1/2 |
| 3-1/2 | 0.5 | 4-1/2 | 6-1/2 |
| 4 | 0.6 | 5-1/2 | 7 |

(Courtesy of Almqvist & Wiksell Förlag AB)

hole diameter. These form a surface of weakness to which the primary blast can break. They also reflect some of the shock waves. Increased use of presplitting for economical reasons has relegated line drilling to a supplementary role. Line drilling may be required prior to presplitting for at least 10 ft in both directions from a 90-deg corner. In this procedure the depth of presplit holes must not exceed that of the line drill holes.

(b) In line drilling the primary blasting is conducted to within two or three rows of the line-drilled row to decrease the burden. The row of primary blastholes nearest the line-drilled row should have 75 percent of the usual hole spacings and should be 50 to 75 percent closer to the line-drilled row than to the last primary row (Fig. 5-22). The powder factor should be reduced.

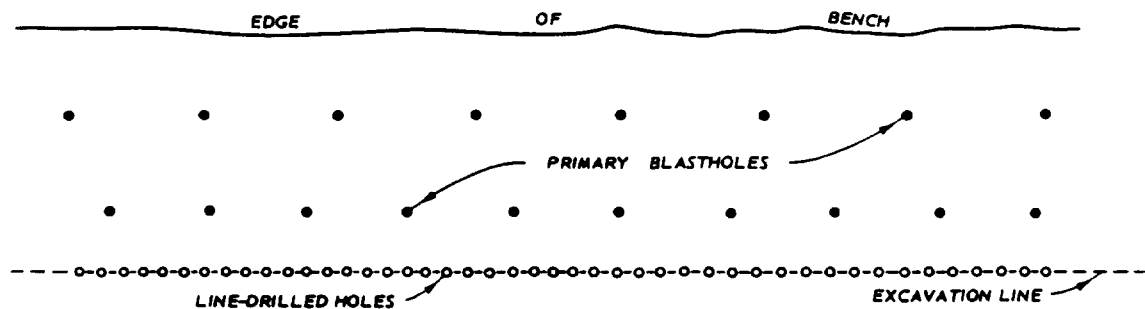

Fig. 5-22. Typical arrangement of line drilling with respect to main blastholes

(c) Because of the tedious drilling necessary, line drilling is most useful in easily drilled homogeneous rock. Despite high cost, line drilling has application in areas where even presplitting may cause excessive wall damage, and it may be required where other structures were adjacent to an excavation.

(d) Close drilling may be specified for finished surfaces not requiring line drilling. Close drilling consists of holes spaced farther apart than line-drilled holes but closer than presplit holes. They may be loaded or unloaded as specified.

d. Precautions in Approaching Final Excavation Surfaces.

(1) Precautionary measures are practiced in an effort to minimize damage beyond the final excavation surface. Subdrilling on berms and final foundations should not be permitted. Some CE specifications require that upon approaching within 15 ft above grade for a concrete dam foundation, blastholes must not be loaded below two-thirds the distance to grade. This in effect reduces the last two regular lifts to 10 and 5 ft (or less) and necessitates a reduction in hole spacing. Subsequent final trimming to grade is usually accomplished with wagon drills or jackhammers and very light charges.

(2) In horizontally stratified rock, special care should be exercised to avoid opening a bedding surface at a comparatively shallow depth below grade by blasting above grade. Such a surface, created by the spalling mechanism (see para 2-3b), may be a very real but unknown hazard to the safety of a concrete dam since it postdates foundation exploration. The phenomenon can occur despite restrictions such as those mentioned above.

(3) Presplit surfaces are preserved by one or more of the following precautions taken in the main blast:

(a) The outside rows may be loaded lighter to reduce vibration and fragmentation.

(b) Berms may be left adjacent to the presplit for later removal.

(c) The delay pattern may be arranged to progress parallel to the presplit (Fig. 5-23) in order to avoid excessive back pressure beyond the presplit.

5-5. Blasting for Control of Rock Sizes. Heavy construction usually requires rock for fills, aggregate, or riprap. Blasting must be designed to produce the proper size and grades of fragments for these

1 Mar 72

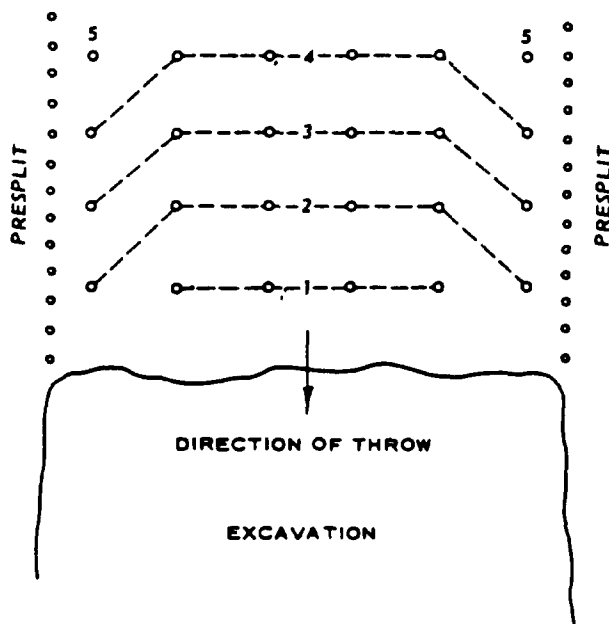

Fig. 5-23. Main charge delays, in numerical sequence progressing parallel to the presplit, reduce back pressure in wall

rock requirements. Maximum fragment size gradation can be estimated by studying the spacing of joints in bedrock or size of talus produced from outcrops.

a. Riprap. The degree of fragmentation in blasting for riprap must be controlled so that proper size and gradation can be obtained. Coyote blasting may be used for producing large rocks for riprap and breakwaters quickly and economically (see c below). In some rocks, low-velocity ammonia dynamites are used because of their low shattering effects. ANFO, while often detonating at a higher velocity than many low-velocity ammonia dynamites, is also used, largely due to its lower price per pound. However, coyote

blasting seldom yields well-sorted rock for riprap, and secondary blasting (mudcapping or blockholing), as well as screening off of fines, may be necessary. Restraint should be exercised in considering the coyote method for jetty stone. Jetty stone quarries commonly contain only about 10 to 20 percent of the best grade large stones and the excessive fracturing and poor control of a coyote blast can ruin a quarry. Depending on their availability, it may be advantageous to mine these stones one by one by multiple-row or irregular array.

b. Aggregate.

(1) Material used for concrete aggregate usually is of small sizes, and therefore blasts should be designed to produce a high degree of fragmentation and thereby reduce handling and crushing costs.

(2) Good fragmentation is commonly achieved by adequately charged, staggered holes in a pattern utilizing the optimum spacing/burden ratio and detonated by a millisecond delay system (Fig. 5-24). Staggered holes allow more of the rock to be affected by the blast and thus produce better breakage throughout. The spacing should

1 Mar 72

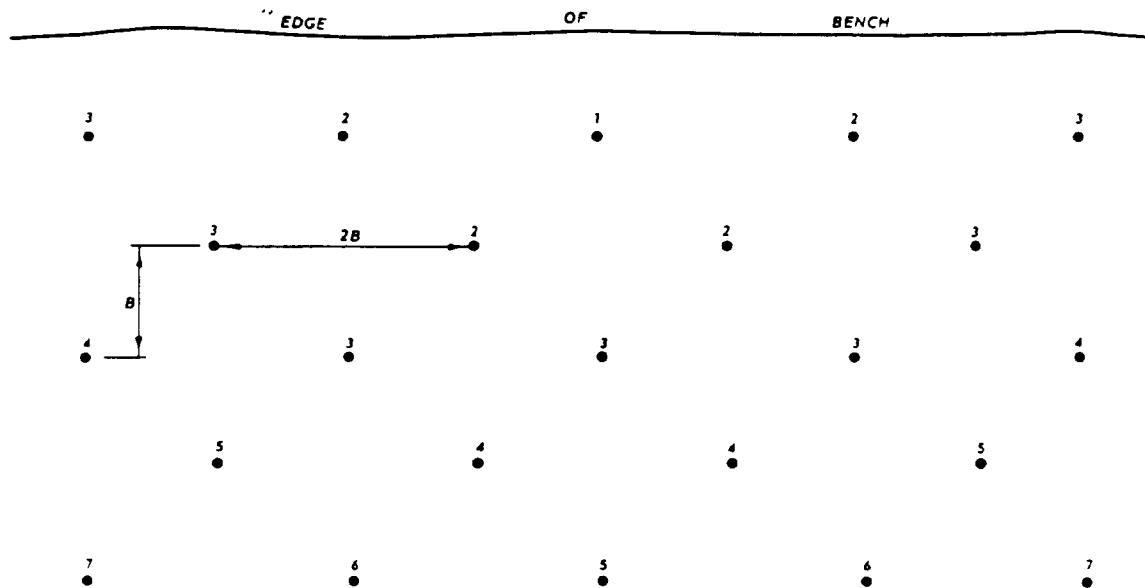

Fig. 5-24. Plan of blasthole pattern for fragmentation of rock to produce aggregate

normally be 1-1/2 to 2 times the burden.

(3) Explosives with high detonation velocity and consequent shattering power are most effective for fragmentation. However, cheaper blasting agents at wider spacing, if properly boosted, fragment well and are usually used.

(4) Small holes (1-1/2 to 4 in.) at closer spacing distribute the explosive and produce better breakage, especially at the top where good fragmentation is difficult to achieve in some rocks.

c. Rock Fill for Dams.

(1) Rock fills commonly consist of all rock fragments below a specified size. A rock fill is most stable and solid if the rock fragments are angular, the largest pieces are smaller than the depth of the lift, and the sizes are well mixed to include a suitable proportion of fines.²⁴

(2) The production of fill can be most easily controlled by using vertical or inclined blastholes and changing the patterns to meet varying rock conditions:

EM 1110-2-3800
1 Mar 72

(3) Coyote blasting is also used for rock-fill production because of its economy and speed. Coyote blasts may yield an excessive amount of fines and dust, however, and these may have to be removed by screening. Elsewhere, oversized material may result and this must be broken by secondary shooting or otherwise removed.

CHAPTER 6. MODIFYING BLASTING TECHNIQUES TO FIT GEOLOGICAL CONDITIONS

6-1. Exploratory Study.

a. Blasting techniques for rock removal, quarrying, and preparation of finished slopes usually should be modified to fit the geological conditions. Because of the extreme complexity of each setting, familiarity with blasting results in similar geological settings is beneficial.

b. Excavations in the vicinity of a job should be examined to observe results of blasting. These should include all highways, quarries, mines, and excavations for hydraulic and other structures. Careful note should be taken of the geological structure, charge geometry, and blasting results. If the results are considered satisfactory, the techniques used may serve as a starting point which can be further refined to fit local details.

c. The results of this exploratory study, conducted before excavation, should be presented as a short report of case examples for use in design. Concurrently with the study of blasting techniques in the vicinity, information on rock physical properties should be collected. Field seismic velocities may serve to classify the rock for blasting purposes, as explained below.

6-2. Rock Types. Rocks can sometimes be classified for blasting purposes according to their seismic velocity. This is, in turn, conveniently converted to characteristic impedance.

a. Seismic Velocity.

(1) The velocity with which stress waves propagate in the rock (usually equal to the sonic velocity) is important, because it affects the distribution in space and time of the stress imposed on the rock by the detonating explosives and is an indirect measure of the elasticity of the rock.¹ Seismic velocities should be measured in the field where the effects of joints and bedding will be included. Velocities of core samples tested in the laboratory usually run considerably higher than velocities measured in the field. Granite, massive limestone, and quartzite tend to have much higher velocities than porous rocks such as sandstone and volcanic rock. Field velocities for granite below the zone affected by surface weathering will average about 15,000 fps. Velocities in porous rock and medium hard to hard shales are of the order of 7,000 to 10,000 fps.

(2) A zone of mechanical and chemical weathering and attack by

1 Mar 72

surface elements is to be found almost everywhere. Seismic velocities vary accordingly (para 6-5). This zone usually exceeds 10 ft in thickness and should be carefully delineated. In this zone, natural joint frequency exceeds that in the firm rock below, and fractures have been opened up. In addition, the weathering products that fill spaces between rock blocks tend to be clayey and have the effect of attenuating seismic waves.

b. Impedance.

(1) Effective rock breakage depends not only on explosive and rock characteristics but also upon an efficient transfer of energy, known as coupling action, from the explosive to the rock. Effective energy transfer depends upon (a) depth of emplacement of charge in rock, (b) efficiency of confinement of charge, and (c) impedance characteristics of both explosive and rock.

(2) Characteristic impedance of an explosive is defined as the product of its mass density and detonation velocity. Characteristic impedance of rock on the other hand is the product of its mass density and seismic velocity. Fig. 6-1 shows a typical impedance calculation for granite.

| |
|---|
| <p>Longitudinal wave velocity = 18,200 fps</p> <p>Unit weight = 165 lb/ft³</p> <p>Mass density = $\frac{165 \text{ lb/ft}^3}{32.2 \text{ ft/sec}^2}$</p> <p>Characteristic impedance = 18,200 fps $\left(\frac{165 \text{ lb/ft}^3}{32.2 \text{ ft/sec}^2} \right)$</p> <p style="text-align: center;">= 93,300 lb sec/ft³</p> <p style="text-align: center;">or = 54 lb sec/in.³</p> |
|---|

Fig. 6-1. Typical impedance calculation for granite

(3) Explosives with impedance nearly matching the characteristic impedance of the rock transfer more energy to the rock. It follows that an explosive loosely placed in a blasthole loses a substantial percentage

of its blasting efficiency. This results from the fact that both rock and explosives have velocities exceeding that of air in the hole by 10,000 fps and usable energy is reduced passing through this low-velocity medium. Table 6-1 shows physical and chemical properties of explosives and common rocks. Ammonium nitrate and shale have similar impedances

Table 6-1. Some Significant Properties of Explosives and Rock in Blasting Work (after Leet²⁵)

Properties of Some Explosives

| Type of Explosive | Specific Gravity | Detonation Velocity fps | Characteristic Impedance lb/sec/in. ³ |
|----------------------|------------------|----------------------------|---|
| Nitroglycerin | 1.6 | 26,250 | 47 |
| Dynamite: | | | |
| 50% Nitroglycerin | 1.5 | 22,650 | 38 |
| 41% Ammonium nitrate | | | |
| 5% Cellulose | | | |
| 80% Ammonium nitrate | 0.98 | 13,100 | 14 |
| 10% Nitroglycerin | | | |
| 10% Cellulose | | | |
| ANFO | | | |
| 93% Ammonium nitrate | 1.0 | 13,900 | 15 |
| 7% Fuel oil | | | |

Properties of Some Rocks

| Rock Type | Longitudinal Wave Velocity fps | Characteristic Impedance lb/sec/in. ³ |
|-----------|-----------------------------------|---|
| Granite | 18,200 | 54 |
| Marlstone | 11,500 | 27 |
| Sandstone | 10,600 | 26 |
| Chalk | 9,100 | 22 |
| Shale | 6,400 | 15 |

(Courtesy of Harvard University Press)

and, therefore, good coupling possibilities. Nitroglycerin (impedance 47) and granite (impedance 54) also suggest an efficient transfer of explosive energy. Characteristic impedances are only one of the criteria

1 Mar 72

needed for selecting the best explosives for the given job. Other factors such as rock structure, water, safety, and economics also play major roles.

c. Compressive and Tensile Strengths.

(1) Following Atchison,¹ "Compressive and tensile strength properties are sometimes used to classify rock with regard to ease of breaking with explosives. A common characteristic of rock that is crucial to the fragmentation process is the high ratio of compressive strength to tensile strength. This ratio ranges from 10 to 100, most rocks being very weak in tension." The ratio has been termed the blasting coefficient (para 2-3). Table 2-1 shows the compressive and tensile strengths for a selected group of rocks with divergent properties.

(2) Fig. 6-2 is an empirical chart useful for estimating blasthole spacing and size and powder factor for rocks of different strength. Actual hole diameter, which is usually the given parameter, must be corrected to effective diameter to compensate for stemming and other inert filling in the hole. Soft minerals, where abundant in rock, also tend to absorb blasting energy and make fragmentation more difficult.

d. Density and Porosity.

(1) Density of intact rock (laboratory measured) often indicates the difficulty to be expected in breaking rock (Fig. 4-3) with the denser material responding best to explosives with high detonation pressures. On the other hand, less dense, more porous rocks absorb energy in ways that make control of fragment size and gradation difficult.

(2) A linear relationship between porosity and in situ sonic (seismic) travel time is shown in Fig. 6-3. This relationship can be used where porosity is known to estimate seismic velocity and, in turn, impedance. Velocity must be corrected for pore fluid in saturated rocks as explained in reference 26.

6-3. Fractures and Fabric. The structural pattern of the rock exerts a major influence on fragmentation in many blasting situations. Blasting patterns should be designed to take advantage of rock structure where possible.

a. Joint Frequency.

(1) In rock removal blasting, closely spaced joints can mean a savings in blasting costs because it will not be necessary to use a sizable part of the energy in fracturing. A pattern and technique using

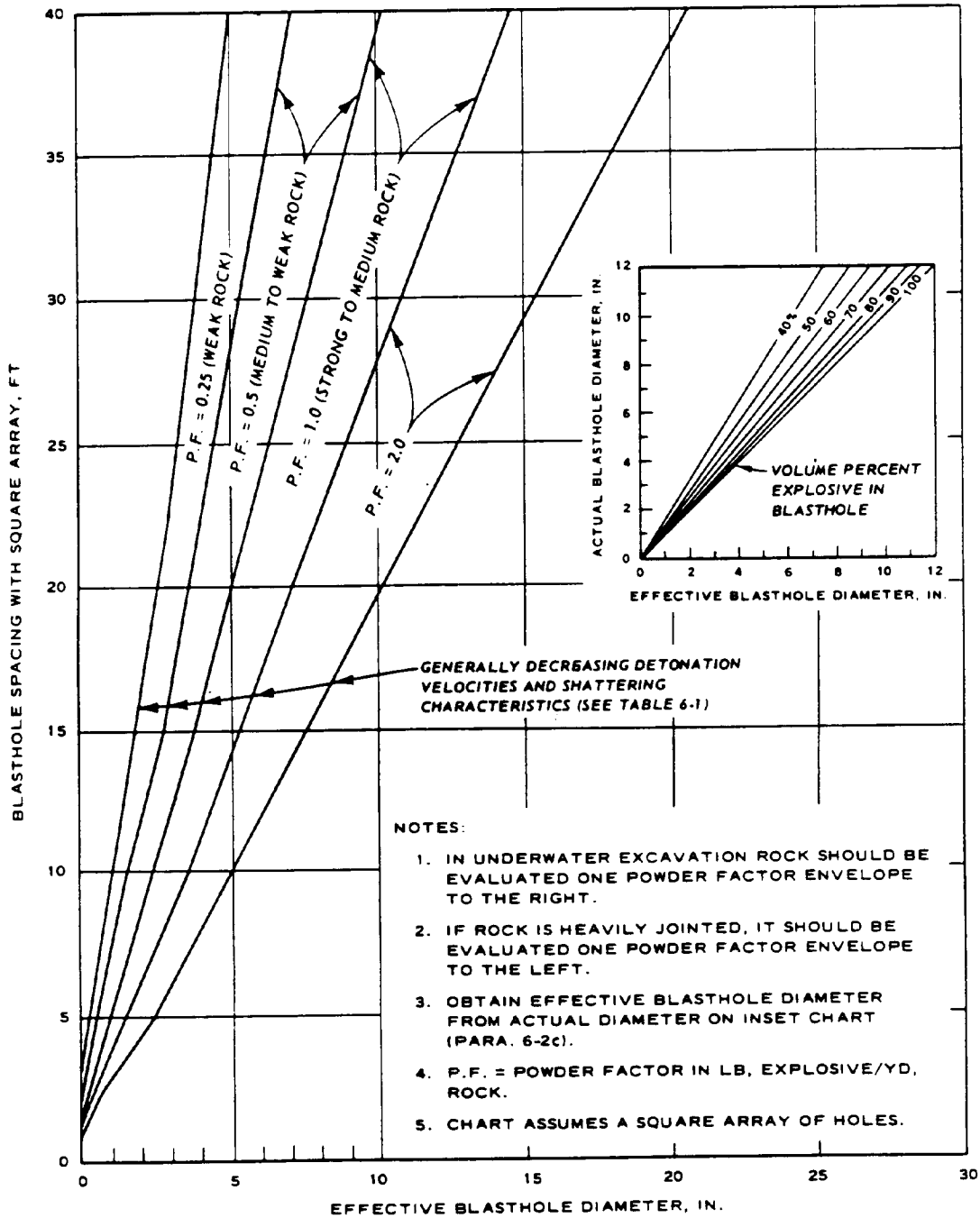
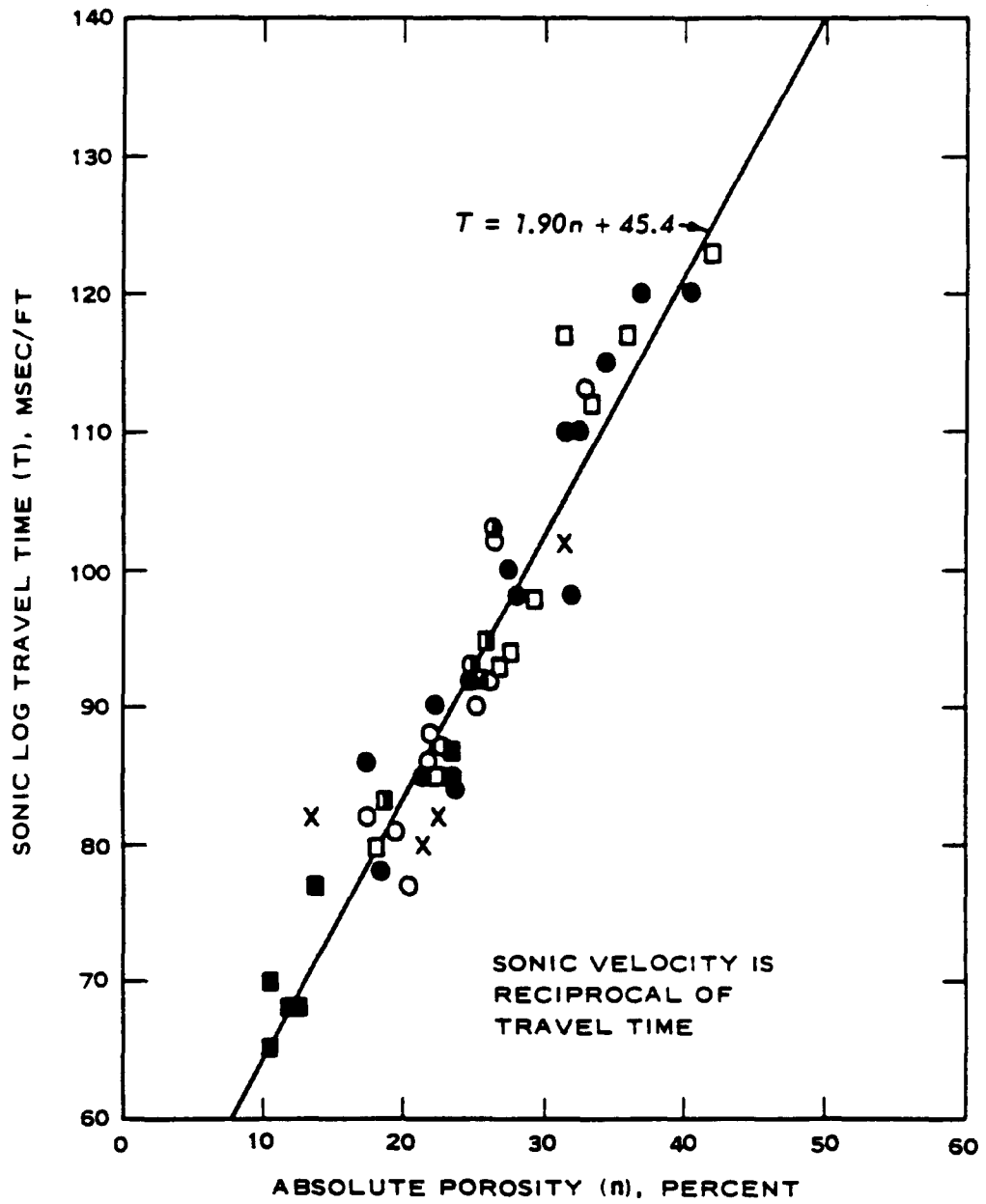

Fig. 6-2. Empirical relation: blasthole spacing and diameter and powder factor for multiple-row blast pattern in rocks of different strengths



(Courtesy of American Society of Civil Engineers)

Fig. 6-3. Sonic log travel time as a function of porosity for a suite of volcanic sedimentary rocks and lava (after Carroll²⁶)

less powder may suffice. Normally, the seismic velocity in a highly fractured rock will be significantly lower than the velocity in similar rock with fewer fractures. It follows that the characteristic impedance will also be lower, and a highly fractured rock can be matched with an explosive or blasting agent with a lower characteristic impedance. Such an explosive has reduced shocking power for fracturing but greater heaving effect for loosening and moving material.

(2) Presplit blasting for a finished rock surface may be more difficult in highly fractured rock depending partly on the nature and attitude of the fractures. Careless presplitting may damage highly fractured rock because liberated gas tends to migrate along these fractures and loosen the mass. This can be minimized by reducing the hole depth and spacing and by stemming carefully.

(3) More effective fragmentation is accomplished where explosive charges lie within the solid blocks bounded by joints.¹ In quarrying highly fractured material, the fragment size of the product will approximate that of the natural fragment, and of course, no quarrying should be attempted where the natural fragment size falls below that desired. Where the natural block size is suitable, a minimal amount of additional fracturing can be tolerated, and energy of the blast should be used for heaving. Again, an explosive with a low detonation velocity may prove best.

b. Cushioning Joint Coatings.

(1) Some joint coatings consist of crystalline material such as quartz and calcite. The properties of these minerals are similar to those of the adjacent rock, so the coatings have little effect. Elsewhere, clayey minerals occurring along fractures can have significant effect. They hold moisture and have plastic rather than elastic properties, so they tend to attenuate the seismic waves. A list of some of these minerals and the usual host rock is presented in Table 6-2.

(2) In rocks where a rapid attenuation of the seismic wave is expected, a heavier charge may give better results. The decision to use heavier charges should, of course, be tempered with the realization that greater crushing will result in the vicinity of the charge. Closer blasthole spacing is a possible alternative modification of the technique. In this manner, adjacent blast-fractured zones can be made to overlap and the seismic zone will be relegated to lesser importance.

c. Orientation of Joints. Blasting technique may need modifications to fit joint orientations. Stability of the excavation is of utmost importance and will take priority over questions of economics, such as are involved in blasting. With this in mind, the long-range stability of

Table 6-2. Clayey Fillings Occurring Along Rock Joints

| <u>Mineral or Mineral Mixture</u> | <u>Host Rock</u> |
|---|--|
| Remolded clay (Same minerals as in host) | Shale |
| Kaolinite | Highly weathered rocks, hydro-thermally altered rock |
| Montmorillonite | Tuff, shale |
| Chlorite | Tuff, andesite, and chlorite schist |
| Sericite | Hydrothermally altered rocks |
| Vermiculite | --- |

Note: Where one or more of the listed host rocks has in the geologically recent past overlain the rocks at the project site, the clayey fillings may have been washed downward along fractures into the new host.

an excavation slope should be a factor along with geological factors considered in designing or modifying a blasting technique. The change should of necessity be made at an early stage of construction.

(1) Orientation in Various Geological Settings.

(a) Idealized systems of fractures may sometimes be predicted for the more common geological settings expected on construction jobs. The simplest is an orthogonal system that can be expected in flat-lying sedimentary strata. This system consists of horizontal joints parallel to the bedding and one or two sets of vertical joints.

(b) The free face may be carried parallel rather than perpendicular to major vertical joints. Not only are large fractures already developed in the major direction, but it can also be expected to be a potentially weak direction in which additional blast fracturing will take place (see e below).

(c) Where this orientation is included in the design of the excavation as a final surface, overbreakage often may be minimized and the slope should be more stable. Conceivably a through-going natural joint surface might be substituted for a presplit surface.

(d) A favorably oriented system of prominent fractures that can be worked into construction design is not necessarily a panacea. It can be detrimental if not properly evaluated. For example, excessive charges can lead to excessive gas migration along these fractures and

movement of a long block of rock into the excavation. This gross overbreakage would be manifested by the opening of fissures along natural joints parallel to the lip of the excavation.

(e) In inclined sedimentary or metamorphic strata, the joint system usually consists of joints inclined parallel to the bedding and one or two sets of joints perpendicular to bedding. Such a geological setting poses a more complicated problem for designing the blasting pattern and loads. Much of the breakage and a large part of the final surface may be along natural joints, so that excavation slopes and blasting patterns should be designed accordingly.

(f) Vertical strata prefer to break along preexisting vertical bedding joints; this plane may be susceptible to overbreakage and later progressive slope movement by stress relief aggravated by blasting. Therefore, a more permanent slope would be attained where oriented either perpendicular to or at a large oblique angle to the strike of the bedding or schistosity. In this case more fracturing would be necessarily done by the explosive so that a denser pattern or heavier charges might be needed.

(g) In massive unbedded rock such as granite, the fracture system is believed to have been determined by regional stresses in the remote geological past. It will commonly consist of nearly vertical joints in two sets striking at right angles. A third set of nearly horizontal sheeting joints may also be present. Such a mass can be treated like one of massive horizontal sedimentary strata. Excavation should be designed where possible to take advantage of the natural joint system, and due caution exercised for overbreakage on natural joints well back from the lip of the excavation. The frequency of fractures in massive rocks is low and consequently blasting problems usually are less acute.

(2) Adverse Orientations. The first and usually most critical adverse joint orientation occurs where a major set of joints is steeply inclined into the excavation. Shear stresses along these joints are high relative to joint shear strengths and disturbance during the blasting may lead to slope failure. Progressive failures can also result from such weakening. Fig. 6-4 shows adverse dip into an excavation in idealized form. As the excavation progresses to depth, the left wall will have considerable overbreakage.

d. Faults and Breccia.

(1) Fault zones may consist of a series of subparallel faults, anastomosing, and enclosing slabs of wall rock or lenses of breccia. Blasting conducted near faults will often break to the fault surface.

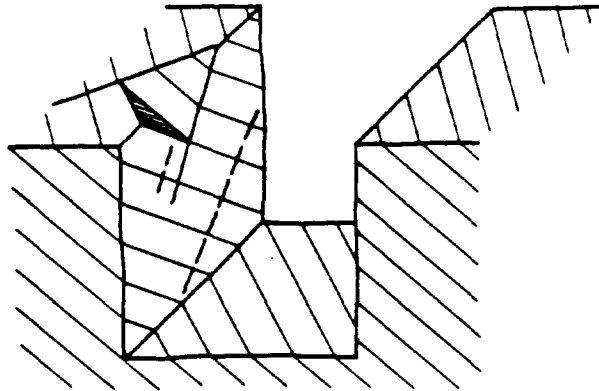
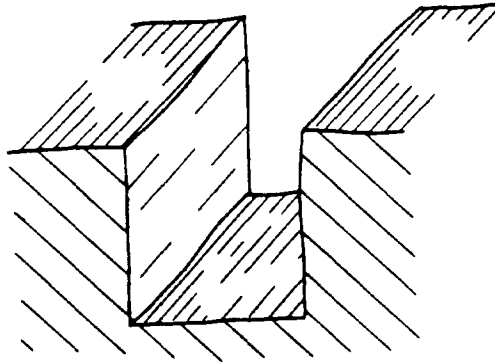

Fig. 6-4: Adverse dip of joints into excavation (left side)

Venting of gases can also occur along permeable breccias or fault zones, causing a loss in the blasting energy and poor results unless deck loading is utilized.

(2) Fault zones and breccia by virtue of their high porosity can also have a cushioning effect on crushing and seismic waves. In such materials, the blasting technique might be modified to the extent that little seismic energy is provided. An explosive with a low detonation velocity might be most satisfactory.

1 Mar 72

(3) Porous faults and breccias constitute potentially weak zones that may be of utmost importance in stability consideration. Corps of Engineers experience in basalt breccia of the Columbia River Plateau indicates that such breccia can be presplit as easily as interbedded basalt and, in fact, stands more stably in some cases. Apparently the shock wave attenuates rapidly in volcanic breccia and the mass has sufficient cohesion to remain intact. Some of these slopes were presplit with every other hole left unloaded.

e. Fabric.

(1) The fabric of a rock, for blasting purposes, is the mineralogical or granular texture that may impart different physical properties in different directions. For instance, the compressive strength of schistose gneiss²⁷ for various orientations varies approximately as indicated in Fig. 6-5.

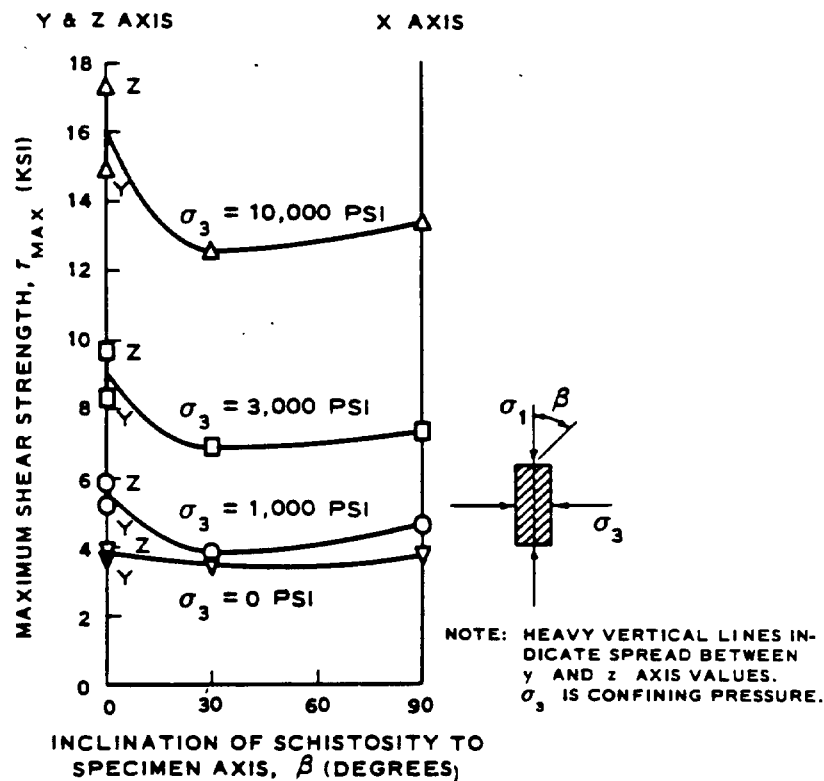

(Courtesy of Laboratório Nacional de Engenharia Civil)

Fig. 6-5. Variation of shear strength with inclination to schistosity (y-z plane) in fine-grained gneiss (after Deklotz, Brown, and Stemler²⁷)

(2) Fabric has been used effectively by the dimension stone industry, which recognized at an early date the difference between "grain," "hardway," and "rift." Fabric directions, particularly in granite, were used to the advantage of the quarryman as favorable or unfavorable planes for breaking out dimension stone. The same technique might be considered in quarrying for engineering materials. Blasting patterns might be designed to break rock preferentially along weak fabric directions so as to reduce powder factor or increase spacing provided the desired product is obtained.

(3) For presplitting, the fabric should be determined so that presplit surfaces may possibly be adjusted to utilize weak planes. Lines of presplit holes may even be adjusted in rare cases to parallel fabric directions. In such cases, the spacing of holes may be as much as doubled. It follows that the major value of knowing fabric is in determining optimum hole spacing and/or charge size.

(4) In conventional production blasting, the nearest free surface should, within reason, be kept parallel to the dominant weak plane in order to promote spalling, general breakage, and movement to that surface.

(5) The in situ stress field is rarely important in surface excavation blasting. The effect is much the same as for fabric to which in situ stress is often geometrically related. Presplitting is easier parallel to the maximum compressive stress.²⁸

6-4. Bedding and Stratification. The dominant structure of many rocks is the bedding. In some igneous rocks which ordinarily do not have bedding, other structures, such as sheeting joints, may function in its place. Where advantageous, the blasting technique should be modified to fit the bedding.

a. Alternating Rock Types.

(1) Careful analysis of the stratigraphy of a site should reveal when a blasting round will lie in more than one rock type. The properties of each rock type are distinct, and the blasting technique may have to be modified for portions in each or the depths of the rounds changed to correspond to the stratigraphy. This applies not only to differences in the properties of the intact rock but also to the differences in properties of differently jointed masses. Ultimately, an array of blastholes passing from layer to layer might be divided vertically and loaded accordingly.

(2) It may be advisable to drill the blastholes to a stratum contact

and thereby outline excavation lifts to conform with the individual stratum. This would be feasible in rocks with well-defined bedding. A finely foliated rock sequence might be treated as one homogeneous unit since it would be unreasonable to divide the charge according to the adjacent wall rock.

(3) Certain geological settings are typified by contrasting rock types. Sandstones and shale are commonly associated in moderately to thinly bedded strata. Elsewhere, limestones and shale are interbedded. Porous tuff and tuff breccia are interbedded with hard lavas, such as basalt and andesite, in volcanic areas. Extremely hard basalts are sometimes separated by thin porous zones of basalt fragments and cinders.

b. Porous and Permeable Beds.

(1) Porous and permeable beds are particularly troublesome where they promote a tendency for the adjacent excavation wall to be lifted on gases migrating from the detonation. It may be necessary to divide the charge into two by decking this interval.

(2) Permeable and porous zones also have a cushioning effect and dissipate seismic energy. As with clayey joint coatings and fault breccia, these low seismic velocity zones may be matched with explosives with low detonation velocity, such as ANFO.

c. Weak Beds or Zones.

(1) It may be necessary to take special precautions where weak zones are indicated in the excavation, particularly pronounced bedding and joints across bedding. The resistance to sliding and slope failure along these surfaces may be divided into two components, an interlock strength and a residual strength. The residual strength may not be sufficient to preserve the slope so that during blasting, all precautions should be taken to avoid lowering the interlock strength by excessive vibration. Weak beds are problems only when they dip toward an excavation. Weak beds dipping steeply away from an excavation may lead to overbreakage and the formation of overhangs. Weak beds are used advantageously for the floor in many quarrying operations inasmuch as the toe tends to break out clean. Excavation walls containing weak zones may need to be redesigned so that the potentially unstable material may be removed. If the slope is designed to be held by rock bolts, exceptional precaution would still be advisable during blasting to avoid unnecessary damage.

(2) A carefully conceived blasting pattern will avoid development

of unstable conditions and may even take advantage of weak zones for rock removal.

d. Dipping Strata. A general rule in dealing with strata dipping toward an excavation is that they are potentially dangerous or unstable. Strata dipping away from an excavation, in contrast, are usually stable and present few problems (Fig. 6-6). However, see discussion of adversely dipping joints in paragraph 6-3c(2).

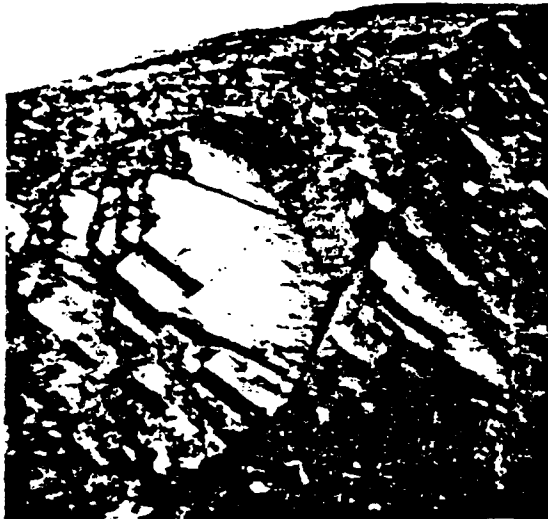

a. Cut in Strata Dipping
Toward Excavation

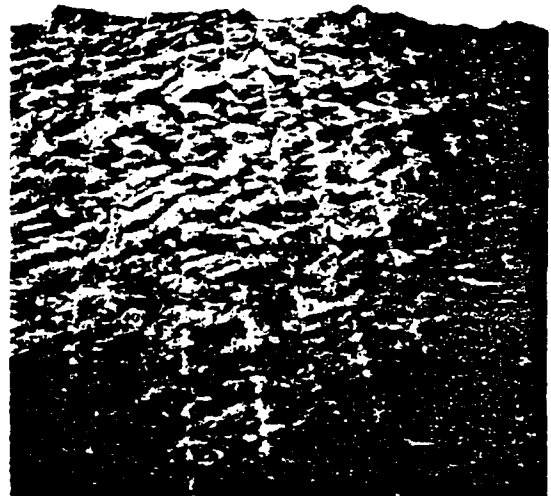

b. Cut in Strata Dipping Away
from Excavation

Fig. 6-6. Effect of dipping strata on stability of excavation. Views of opposite walls of a cut through argillite

e. Cavities.

(1) Cavities in an excavation site may have a marked effect on blasting. The air space may tend to decouple the explosive and rock and decrease the efficiency. Another adverse effect is that explosives, particularly in bulk or slurry form, can be lost into or through a cavity that intersects the hole. Also overloading will result in extra hazards of flyrock. For these reasons, a record of the volume of explosives loaded in each hole should be maintained by the contractor. When there is an indication of a loss of explosives in cavities, the zone should be located and corrective measures taken to seal it.

1 Mar 72

(2) The cavity may be sealed by filling with sand, by grouting, or by plugging off the hole above and below the cavity. Where the hole is plugged, a portion of the explosive charge should lie on either side and additional care will be required in priming and detonation. Although such measures may be expensive, they may be justified, for a misfire or inefficient round will be more costly.

6-5. Weathering.

a. The weathering effect is twofold. First, the properties of the rock are altered, and second, this change of properties is localized in a layer parallel to the ground surfaces so that crude stratification is developed.

b. Field seismic surveys together with available boring data will usually resolve the problem. They show the thickness of the weathered zones and the P-wave velocities of each material. Velocities in more fractured weathered zones are less than those in the fresh rock below, and blasting techniques should be adjusted. A weathering coefficient (Table 6-3) can be a useful guide for modifying blasting for the weathered zones. The characteristic impedance of the explosive recommended

Table 6-3. Classification of Laboratory Samples of Monzonites According to the Degree of Weathering (from Iliev²⁹)

(Courtesy of Laboratório Nacional de Engenharia Civil)

| <u>Degree of Weathering</u> | <u>Velocity of Ultrasonic Waves, m/s</u> | <u>Coefficient of Weathering, K</u> |
|-----------------------------|--|-------------------------------------|
| Fresh | >5,000 | 0 |
| Slightly weathered | 5,000-4,000 | 0 - 0.2 |
| Moderately weathered | 4,000-3,000 | 0.2-0.4 |
| Strongly weathered | 3,000-2,000 | 0.4-0.6 |
| Very strongly weathered | <2,000 | 0.6-1.0 |

Note: $K = \frac{\text{velocity fresh} - \text{velocity weathered}}{\text{velocity fresh}}$

m/s = meters per second

for use in weathered rock is found by multiplying the characteristic impedance of the explosive used in fresh rock by the factor, $1 - K$. A more conventional method is to use the same explosive but to increase the powder factor when weathered material is absent.

1 Mar 72

c. One way of simplifying the handling of weathered material is to blast and excavate it in one or two lifts apart from material below. By partially excavating down to the lower limit of a weathered zone, the mass is simplified to one with uniform properties. Because of the decreased seismic velocity, upper lifts might respond to lower velocity explosives for best impedance matching and efficiency. In the transition zones and in the fresh rock below, detonation velocity might be increased farther.

d. Some weathered rocks are so decomposed that they can be treated as soil and excavated without blasting. A seismic velocity of about 4,000 fps is a routinely accepted upper limit for rock that can be loosened by ripping without blasting. With improvements in ripper design and techniques, material with seismic velocities as great as 7,000 fps can be ripped. However, there are other factors that may be involved in determining whether rock can be ripped economically.

e. In a few special types of weathering, the lower portion of the zone has material characterized by a greater strength, as in laterite and caliche.

6-6. Groundwater.

a. Zones of various degrees of saturation by groundwater form another type of crude stratification parallel to the ground surface, with properties varying accordingly. Saturated zones require explosives with greater water resistances and necessitate more care in stemming. Important distinctions must be made in the properties of the materials and the results to be expected. The filling of void space by water tends to increase the P-wave velocity in the mass and improves wave transmission. The coupling between the explosive and the rock is also improved.

b. Unsaturated material above the water table should be blasted separately from that in the capillary zone and below where reasonable. After removal of the unsaturated material, however, it should be verified that the material yet to be excavated is still saturated. Disturbance during excavation may have caused groundwater to migrate. Fluctuations from rainy to dry seasons should be considered also.

c. The results of blasting during removal of the unsaturated zones should be carefully evaluated for guidance in the blasting below the water table. Where these previous results are considered satisfactory, modifications might consist of the use of explosives with a higher detonation velocity for better coupling to the saturated rock, and/or the use of smaller loads and wider hole spacings.

CHAPTER 7. DAMAGE PREDICTION AND CONTROL⁽¹⁾7-1. Introduction.

a. A necessary part of all blasting operations is the estimation of potential damage to nearby surface and underground structures and to local rock surfaces that are to remain in place. Damage to nearby surface structures, such as buildings, bridges, concrete foundations, etc., can result from airblasts, ground vibrations, and flyrock. Damage to underground structures such as tunnels and tunnel linings can result from ground shock and subsequent vibrations. Damage to rock surfaces results from crack propagation into the solid rock immediately behind the blasthole.

b. Equations for predicting the amount of airblast, ground motion, flyrock, and cracking require so-called site constants obtained by performing simple controlled tests with instrumentation and careful observation. From only a few such tests, it is possible to determine the necessary constants so that reasonably accurate predictions can be made.

c. Methods and techniques for preventing damage by controlling the amount of airblast, ground vibration, flyrock, and cracking are generally known and should be made a part of all blasting operations. Damage criteria have been developed for various types of structures and ground vibrations. These criteria can be used with propagation laws for air and ground vibrations to estimate safe charge sizes for various distances to structures.

7-2. Airblast. Airborne vibrations and airblast are generated when explosives are detonated in stemmed drill holes in rock by the following processes:

Conversion of ground vibration to air vibrations at free rock surfaces.

Release of high pressure gases to the atmosphere through the broken rock.

Release of high pressure gases to the atmosphere through the drill hole after the stemming has been pushed out.

(1) This chapter, except paragraph 7-4, was prepared by Wilbur I. Duvall, U. S. Bureau of Mines. Also see EM 385-1-1, General Safety Requirements.

1 Mar 72

Release of high pressure gases to the atmosphere by exposed detonating fuse lying on the surface of the rock.

Of these four processes the last three contribute the most energy to the airblast waves.

a. Damage from Airblast. For residential structures, cracked plaster is the most common type of failure in airblast complaints. However, research has shown that windowpanes fail before any structural damage to the building occurs.³⁰ Airblast pressures of only 0.03 psi can vibrate loose window sashes, which may be a source of annoyance complaints but do not represent damage. Windowpanes that have been stressed by poor mounting or house settlement may fail when subjected to pressures as low as 0.1 psi. Airblast pressures of 1.0 psi will break windowpanes and as pressures exceed 1.0 psi, plaster cracking, which depends on wall flexibility, will start to develop. Thus, it is recommended that air pressures exerted on structures resulting from blasting be kept below 0.1 psi.

b. Propagation of Airblasts.

(1) Extensive research has been conducted on the determination of the airblast pressure generated by the detonation of explosives on the surface of the ground.³¹⁻³⁴ From the data given by Perkins,^{33,34} the airblast pressure as a function of distance D and charge size W for the explosion of spherical charges at the ground surface under normal atmospheric conditions is given by

$$P = 175 \left(D/W^{1/3} \right)^{-1.4}$$

where

P = airblast pressure, psi

D = distance, ft

W = charge size, lb

For surface excavation, the explosives are placed in drill holes and confined by stemming, which reduces the amount of airblast considerably.

(2) Fig. 7-1 shows the airblast to be expected for different depths of burial DOB for buried spherical charges. In this figure both depth of burial, in feet, and distance from charge, in feet, are scaled by the cube root of the charge weight, in pounds. The plotted points in Fig. 7-1

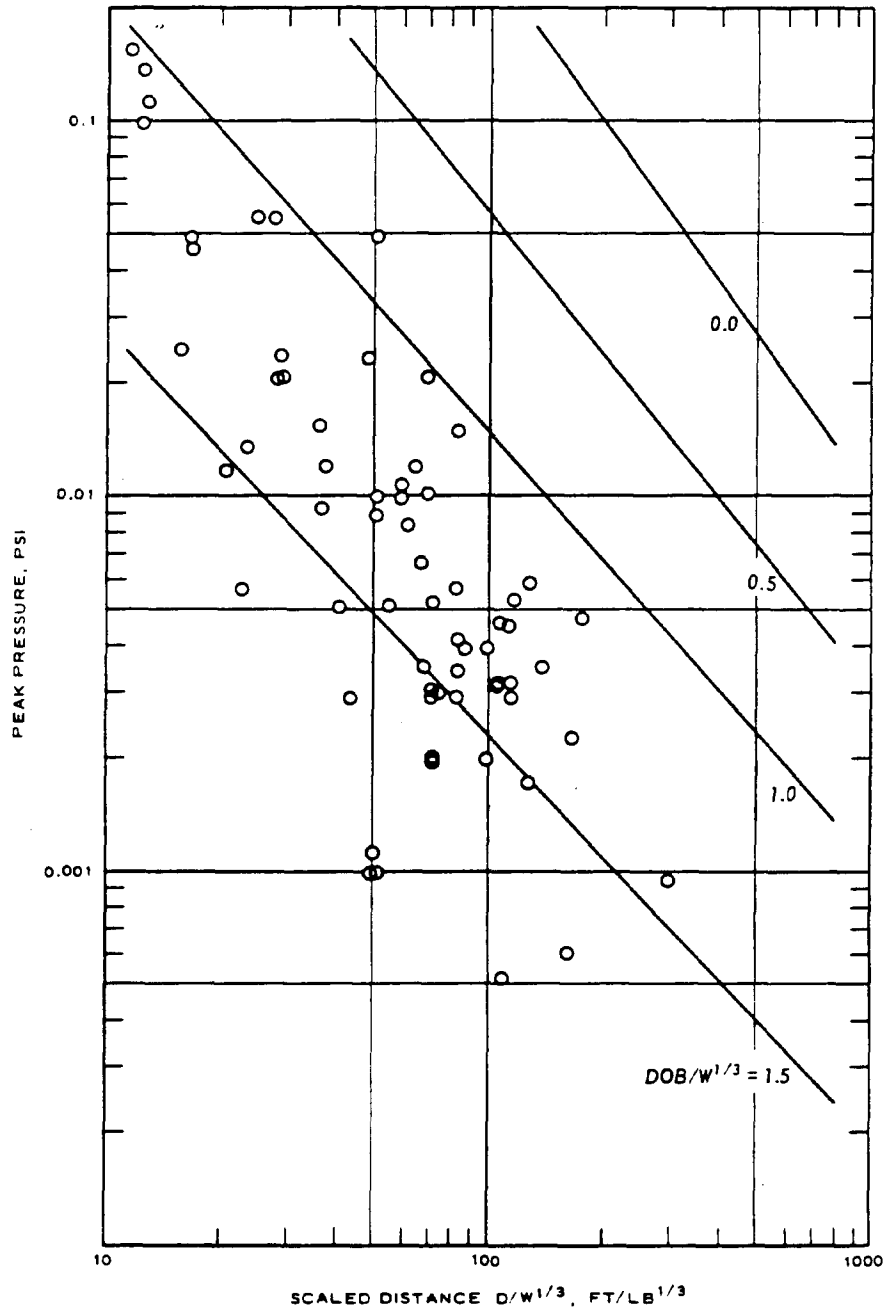

Fig. 7-1. Propagation laws for airblast pressure from spherical charges for various scaled depths of burial and from quarry blasting rounds

1 Mar 72

are Bureau of Mines observed airblast pressures for multiple-hole quarry blasts. For the quarry blast data, the charge weight is the maximum charge detonated per delay interval. The charge per delay interval is the sum of the charges in the holes that are detonated simultaneously. From the location of the data points, the scaled depth of burial for the quarry blast is usually less than 1.0. This scaled depth of burial corresponds roughly to the scaled burden for each shot hole. From Fig. 7-1, a scaled distance of $20 \text{ ft/lb}^{1/3}$ should be sufficient to assure airblast pressures of less than 0.1 psi for multiple-hole quarry blasts that are well stemmed and cap initiated.

c. Excessive Airblast Pressure.

(1) The primary causes of excessive airblast pressures are insufficient burden, insufficient stemming in each blasthole, exposed detonating fuse, and adverse weather conditions. A well-designed blasting round that breaks and moves rock efficiently seldom produces excessive airblast pressures. If detonating fuse is used, it should be covered with sand to minimize airblasts. Exposed detonating fuse and lack of stemming in blastholes can increase airblast pressures by a factor of 10 or more.

(2) Under certain adverse weather conditions, such as temperature inversions, cloud cover, and high wind velocity, local high airblast-pressure regions can develop at large distances from the shot point.^{33, 34}

(3) These local high-pressure regions are a result of focusing of sound waves. As temperature inversions exist most frequently during the period from 1 hr before sunset to 2 hr after sunrise, blasting operations should be confined to the intervening daytime period if airblast is to be avoided. Postponement of blasting operations should be considered during daytime hours when a heavy low-level cloud cover exists. Also blasting operations should not be conducted when wind velocities in excess of 15 mph are in the direction of nearby residential structures.

d. Recording Equipment.

(1) Airblast pressures are recorded generally by two types of equipment--microphones and piezoelectric pressure gages. The microphone has proven satisfactory for pressure measurements from 0.1 to 1 psi. Overpressures greater than 1 psi are usually recorded by the piezoelectric type of gage.

(2) Air waves from multiple-hole delayed blasting produce recording problems not encountered with instantaneous surface blasts. A

record of the air wave from millisecond delayed blasting does not appear as a typical single pulse, but instead, has an oscillatory character that can have rarefaction phases comparable to the compressional phases. Therefore, sound recorders with slow response may not give true peak overpressure values because of addition of peaks that are only a few milliseconds apart.

7-3. Ground Vibrations. The detonation of an explosive confined in a drill hole generates a large volume of gas at high temperatures (2,000-5,000° C) and high pressures (0.2×10^6 to 2.0×10^6 psi). The sudden application of a high pressure to the cylindrical surface of the drill hole generates a compressive stress pulse in the rock, which travels outward in all directions (para 2-2). This compressive pulse constitutes the source of the ground vibrations that result when explosives are detonated in holes in rock. These vibrations are extremely intense near the source but decay in amplitude as they travel away from the source. Therefore, it is important to know the general relationship between the intensity of these vibrations as a function of the size of charge detonated and the distance from the source.

a. Damage from Ground Vibration.

(1) The level of ground vibration necessary to cause various types of damage to various types of structures can best be established by case-history studies where the ground vibrations are measured near a structure and the resulting damage correlated with the level and frequency of ground vibration. An inspection of building and structures in the area of potential damage including photographs and measurements before and after blasting would be useful in handling damage claims.

(2) For residential structures the initial indication of damage from ground vibrations produced by blasting is extension of old plaster cracks or dust falling from old plaster cracks. An increase in severity of ground vibration can cause intensified cracking of plaster, falling of plaster, cracking of masonry walls, and separation of partitions from exterior walls and chimneys.

(3) Damage to structures is most closely associated with the peak particle velocity of the ground vibration in the vicinity of the structure. Fig. 7-2 summarizes the damage data from the literature. Major damage may be defined as serious cracking and fall of plaster, and minor damage as opening of old plaster cracks. There is a large spread in the data because the amount of vibration that a given structure can withstand varies considerably from structure to structure depending upon its method of construction, past stress history, and conditions

1 Mar 72

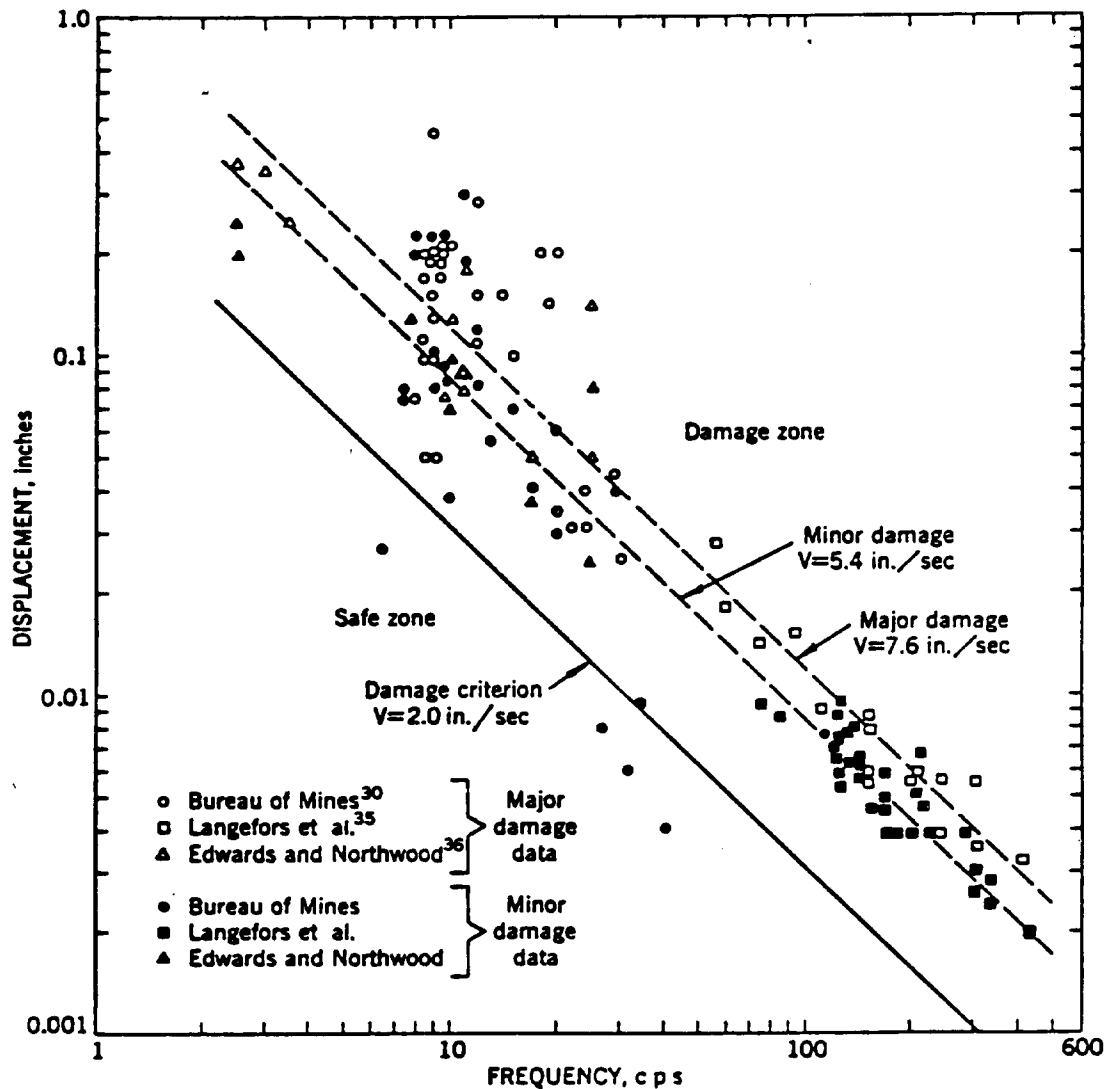

Fig. 7-2. Summary of damage criterion data for frame structure (modified from ref 37)

of the ground upon which it rests. On the average, major damage begins to occur at a peak particle velocity of 7.6 inches per second (ips) and minor damage at 5.4 ips. On the basis of the data in Fig. 7-2 a particle velocity of 2 ips appears reasonable as a separation between a relatively safe zone and a probable damage zone. Just because a vibration level of 2 ips is exceeded, damage will not necessarily occur. For example, Fig. 7-3 summarizes all the published data where the

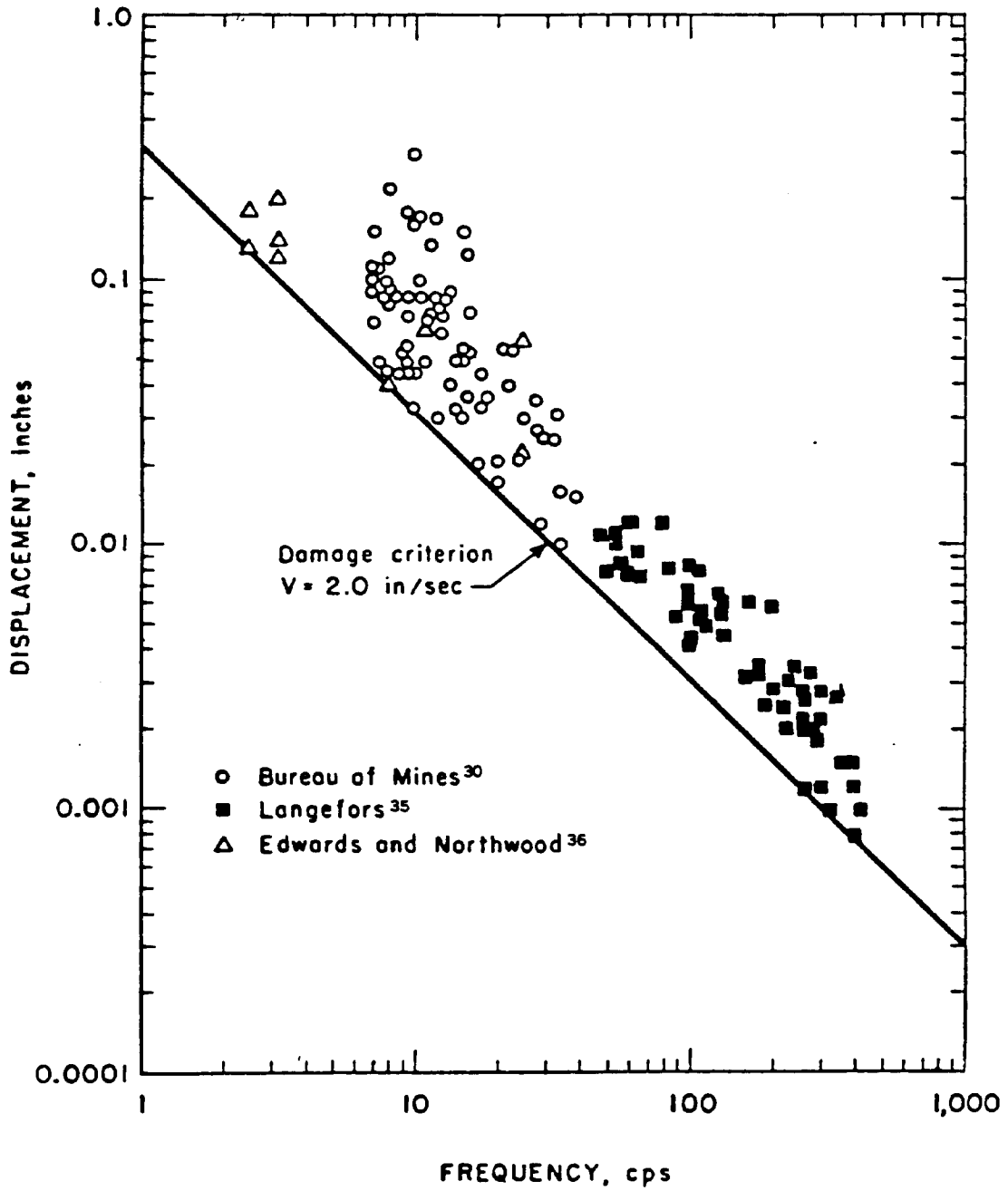

Fig. 7-3. Summary of nondamaging data above recommended safe vibration level for frame structures (modified from ref 37)

1 Mar 72

vibration level was above 2 ips and no damage was detected. Also, just because the vibration level is below 2 ips, does not mean that damage will not occur in some structures. Very low vibration levels can be associated with damage in poorly constructed structures as in a structure previously stressed by settlement or unstable soil conditions.

(4) From the data given in Figs. 7-2 and 7-3, and taking into consideration the spread of the data, it may be concluded that if one or more of the three mutually perpendicular components (radial, vertical, and transverse) of vibration in the ground near a residential structure has a peak particle velocity in excess of 2 ips, there is a fair probability that damage to the structure will occur.

(5) For many years the criterion for damage to residential structures was based upon energy ratio.³⁸ As defined, energy ratio was equal to the acceleration squared divided by the frequency in cycles per second (cps); an energy ratio of 3 was considered safe and an energy ratio of 6 was considered damaging to structures. It should be noted that for sinusoidal vibrations, an energy ratio of 3 corresponds to a peak particle velocity of about 3.3 ips. Thus, the newer recommended safe vibration level for residential structures is about the same as that recommended by Crandell³⁸ when one takes into account that energy ratio is based on resultant acceleration. If all three components of particle velocity had a maximum value of 2 ips at the same time, the resultant velocity would be 3.5 ips.

(6) It should be emphasized that the discussion above applies to residential structures where the vibrations were the result of detonating normal explosives buried in holes in rock or soil. Figs. 7-2 and 7-3 show that the frequencies of the vibrations were generally above 8 cps. Most residential types of structures have resonant frequencies below 8 cps, thus the phenomenon of resonance is not too important in the above-mentioned data. However, for very large blasts, such as underground nuclear blasts, the predominant frequencies in the vibrations would be lower than 8 cps. Thus, the phenomenon of resonance for residential structures would be important. As a result the criterion for safe vibration levels for no damage to residential structures could be much lower than 2 ips for underground nuclear blasts. The large number of claims of damage resulting from the Salmon nuclear event, a deep underground explosion where the vibration levels were less than 2 ips, seem to substantiate this conclusion.³⁹

(7) Vibration levels that are safe for residential structures are annoying and often uncomfortable when experienced by people. Complaints from the public are as troublesome as legitimate damage claims. Fig. 7-4 shows the subjective response of the human body to sinusoidal

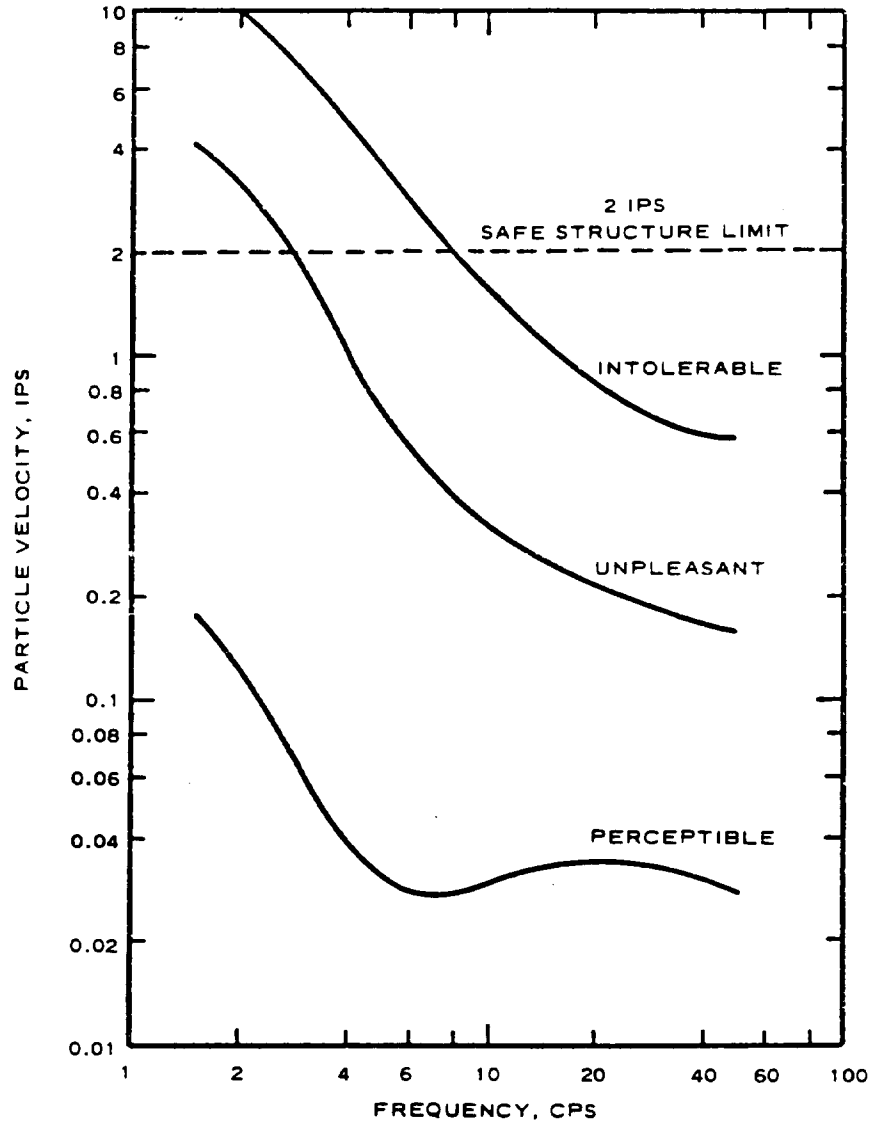

Fig. 7-4. Subjective response of the human body to vibratory motion

vibratory motion.⁴⁰ This figure shows that in the range of 10 to 100 cps, vibration levels between 0.1 and 0.3 ips are considered unpleasant by most people. As the major frequency components of vibrations from quarry blasts usually lie in the range of 10 to 100 cps, it is recommended that where possible, vibration levels be kept below 0.2 ips to minimize the number of nuisance complaints from owners of residential structures.

1 Mar 72

(8) In rural areas the most common complaint from the public may be of damage to water wells. The trouble may be only temporary agitation and cloudiness of the water or the well may be damaged and require repairs. A program of observation of several wells, if possible during a period of testing, should help in reducing the problem and complaints.

(9) Particle velocity damage criteria for unlined tunnels can be inferred from data obtained during the Underground Explosion Test Program.^{41,42} The outer limit for irregular spalling and falling of loose rock from the tunnels when subjected to ground vibrations from blasts on the surface were at average scaled distances of 4.4 ft/lb^{1/3} for tunnels in granite and 5.1 ft/lb^{1/3} for tunnels in sandstone. The average measured strain ϵ in granite at a scale distance of 4.4 ft/lb^{1/3} was 200 microinches/inch ($\mu\text{in./in.}$), and the average observed strain in sandstone at a scale distance of 5.1 ft/lb^{1/3} was 250 $\mu\text{in./in.}$ The average propagation velocity c in granite was 14,500 fps and in sandstone was 7,400 fps. Using the relation

$$v = \epsilon c$$

the particle velocity v for damage to occur in unlined tunnels in granite is computed as 35 ips and in sandstone as 22 ips.

(10) Dynamic breaking strains for five rock types were obtained by instrumented crater tests.^{43, 44} Table 7-1 summarizes the breaking strains, propagation velocities, and calculated particle velocities for failure. Based on these data, a damage criterion for unlined tunnels subjected to ground vibration from explosion is about 20 ips for the

Table 7-1. Strain and Particle Velocity at Failure for Five Rocks

| Rock Type | Dynamic Breaking Strain $\mu\text{in. in.}$ | Propagation Velocity fps | Particle Velocity at Failure ips |
|-----------|--|--------------------------------|---|
| Granite | 360 | 18,500 | 80 |
| Sandstone | 550 | 5,000 | 33 |
| Marlstone | 310 | 13,000 | 48 |
| Chalk | 300 | 7,500 | 27 |
| Salt | 310 | 14,500 | 54 |

weaker rocks with somewhat larger values for the stronger rocks. If controlled tests at a given site are not possible, it is recommended that ground vibrations be kept below 20 ips to prevent damage to rock walls of underground openings near blasting operations.

(11) A particle-velocity damage criterion for massive monolithic concrete structures, such as bridge piers, concrete foundations, concrete dams, and concrete tunnel linings, can be estimated from average physical properties of concrete and the relation

$$v = \frac{\sigma}{\rho c}$$

where

v = particle velocity for failure, fps

σ = failure tensile strength, psi

ρ = mass density, $\frac{\text{lb sec}^2}{\text{ft}^4}$

c = propagation velocity, fps

For example, if $\sigma = 600$ psi, $\rho = \frac{140 \text{ lb/ft}^3}{32.2 \text{ ft/sec}^2}$ or 4.3, and $c = 15,000$ fps,

then $v = 16$ ips. Thus, an estimated safe vibration level for concrete structures would be about 10 ips.

(12) As the safe vibration levels for underground rock structures and massive concrete structures have been inferred from physical property data, it is recommended that these values be used with caution by approaching these safe levels gradually. Thus, instrumentation should be used to determine the vibration levels at the structures as the scaled distance from the blast is reduced.

b. Recording Equipment.

(1) Ground vibrations resulting from blasting are usually measured by means of either a displacement or velocity seismograph. These instruments are usually self-recording and can be purchased as a complete unit. However, it is also possible to use displacement gages, velocity gages, or accelerometers with appropriate amplifiers and recorders.

(2) Displacement seismographs consist of three mutually perpendicular pendulums. Magnification of the displacement, by means of

optical lever arms, is usually fixed at some value between 25 and 75. The displacement seismograph is generally mounted on three leveling screws that rest on the ground or floor of a structure, and the center of gravity of the instrument is above the level of the surface on which the instrument rests. A permanent trace of the ground displacement as a function of time is made on 2- to 3-in.-wide photographic paper traveling at a speed of 4 to 5 ips. The useful frequency range is from about 5 to 50 cps; the dynamic recording range, which is the ratio of maximum signal deflection to minimum readable deflection, is about 20, and the maximum acceleration allowable is approximately 0.2 g.^{45,46} For a sinusoidal vibration of frequency f , the relation between peak acceleration a and peak displacement u is

$$a = 4\pi^2 f^2 u$$

Thus, the allowable range of displacement that can be recorded depends upon the frequency of the vibration. Displacement seismographs can be used to measure the peak particle velocity v of the ground motion. The maximum slope of the displacement-time record is the peak particle velocity. If sinusoidal vibrations are assumed, the particle velocity can be calculated from

$$v = 2\pi f u$$

(3) As damage criteria are usually based on particle velocity, it is recommended that particle velocity be measured directly rather than be inferred from displacement or acceleration. Velocity seismographs for recording vibration from blasting consist of three mutually perpendicular coils free to move in a magnetic field. These are mounted in a box, which may be buried in the ground or placed on the surface of the ground or floor of a structure. Associated with the seismometer box is another box containing amplifiers, galvanometers, a multiple-channel paper recorder, and a d-c power supply. The sensitivity of these seismographs is adjustable in the range from 20 to 0.2 in. of record motion per 1 ips ground motion, and their useful frequency range is from 2 to 300 cps. The recording paper speed is about 4 ips. Velocity seismographs also have a greater dynamic range and a better frequency range than the displacement type seismographs. Because the seismometer box can be buried in the ground, the limitation of the 0.2-g level inherent in displacement seismographs is not applicable.

c. Propagation of Ground Vibrations.

(1) Charge size per delay interval and distance from the blast are

the two most important parameters that determine the vibration levels produced in the ground by multiple-hole quarry blasting. Other variables such as burden, spacing, hole depth, hole size, stemming height, and type of explosive have only a minor effect upon the vibration level and in quarry blasting can be neglected.

(2) Controlled tests to study the vibration levels from instantaneous and millisecond-delayed blasts demonstrated that the vibration level in the ground was dependent on the charge weight per delay interval and not on the total charge weight for millisecond-delay blasts.⁴⁷ An increase in the number of delay intervals does not affect the vibration level provided that the delay interval is greater than 8 msec and the charge weight per delay remains constant.

(3) Normally, for spherical or concentrated charges, seismic effects in the ground would be expected to scale in proportion to the cube root of the charge weight. However, for quarry blasts variations in the charge size per delay interval are obtained by changing hole size and the number of holes per delay interval, with the charge length remaining practically constant. This method of changing charge size per delay interval is more nearly represented by square root scaling. A general propagation relation for peak particle velocity as a function of distance and charge size per delay interval has been established⁴⁸ as

$$v = H (D/W^{1/2})^{-\beta}$$

where

v = peak particle velocity of any one component of vibration
(radial, transverse, or vertical), ips

D = distance from blast area to point of measurement, ft

W = charge weight per delay interval, lb

H, β = constants (e below).

The quantity $(D/W^{1/2})$ is the scaled distance.

(4) A typical example of data for peak particle velocity versus scaled distance for one particular site is shown in Fig. 7-5. Note that the data for each component of peak particle velocity tend to group about straight lines on log-log coordinates and that the standard deviations of the data about these straight lines are less than ± 50 percent of the mean values. If one assumes that the data given in Fig. 7-5 are representative of all future blasts at this particular site, the probability of having a blast that produces a vibration level greater than 2 ips at a

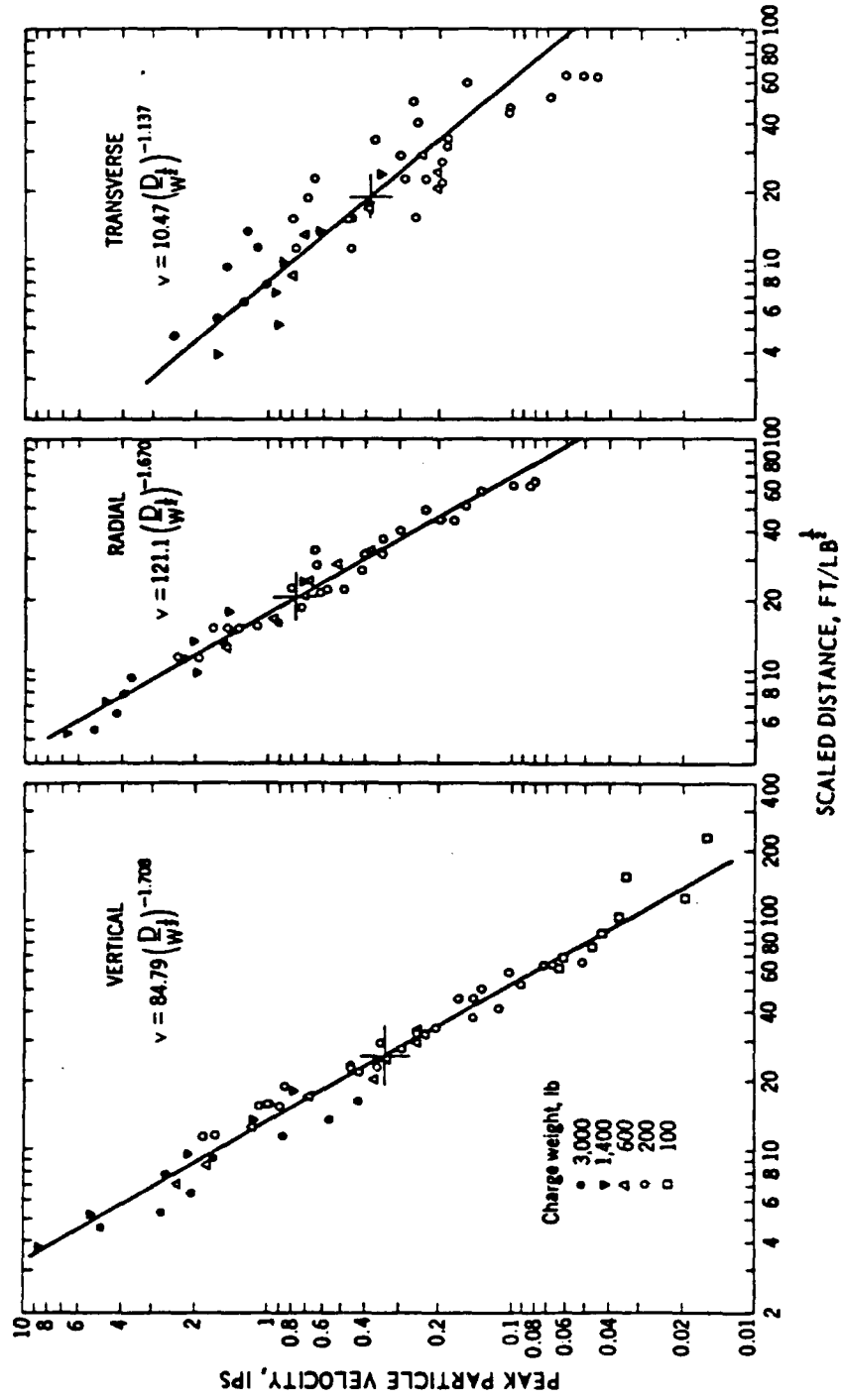

Fig. 7-5. Particle-velocity data versus distance for one site

scaled distance of $20 \text{ ft/lb}^{1/2}$ is relatively small. Thus, for this particular site a safe scaled distance for prevention of damage to residential structures by blasting vibrations is $20 \text{ ft/lb}^{1/2}$. This scaled distance can serve as a guide at this particular site for determining the weight of explosive per delay interval that can be used at a given distance from a residential structure without exceeding the safe vibration level. All that is necessary is to make the charge weight per delay interval sufficiently small or the distance sufficiently large so that the quantity $D/W^{1/2}$ is greater than $20 \text{ ft/lb}^{1/2}$.

(5) The above-described procedure for obtaining a safe scaled distance for prevention of damage to structures by means of ground vibrations from blasting implies that at a particular site, a series of blasting tests must be conducted to determine the particle-velocity propagation relation for that site. Such a procedure may not be necessary if one is willing to accept rather large scaled distances and if one has available particle-velocity propagation data from a large number of sites.

(6) A scaled distance of $50 \text{ ft/lb}^{1/2}$ can be considered a minimum safe scaled distance for any blasting site without prior knowledge concerning its vibration characteristics. If at any site a scaled distance of $50 \text{ ft/lb}^{1/2}$ limits the charge weight per delay interval unreasonably because of the close proximity of residential structures, it may be possible to use a smaller scaled distance by performing tests at the site to determine the constants in the propagation equation.

d. Reducing Vibrations.

(1) As explained above, the general propagation relation for ground vibrations from blasting is of the form

$$v = H (D/W^{1/2})^{-\beta}$$

The quantity $(D/W^{1/2})$ is the scaled distance. The particle velocity varies inversely with scaled distance, and ground vibration levels can be reduced by increasing the scaled distance. To increase the scaled distance requires increasing the distance or decreasing the charge size per delay interval.

(2) For instantaneous blasting, the charge size can be reduced by using standard or millisecond-delay detonators. For delayed detonations the effective charge size that controls the level of vibration is the maximum amount of charge detonated per delay interval. The total number of delays used does not affect the vibration level. Delay intervals

as short as 8 msec are as effective in reducing the vibration levels as are the longer delay intervals. There may be occasions when 5-msec delay intervals are too short for effectively reducing vibration levels.

(3) For delayed blasting the maximum charge per delay interval can be reduced by reducing the number of holes that detonate per delay interval. For delayed blasting where the number of holes per delay interval is one, the maximum charge size per delay interval can be reduced by decreasing the charge per hole. To reduce the charge per hole requires changing the hole depth, hole size, burden, spacing, and stemming.

(4) In some special cases it may be necessary to reduce the charge size per delay interval by using decked charges in a single hole separated by sufficient stemming to prevent sympathetic detonation. Each deck charge is then detonated at a different delay interval.

(5) A presplit failure plane between the blast area and a structure may or may not be effective in reducing vibration levels at the structure. This method of reducing vibration levels at a given location is not recommended without controlled tests with instrumentation. For a presplit fracture plane to effectively reduce vibration levels, it must intercept the travel path for the ground vibration and be a good reflector. To be a good reflector the presplit fracture plane must form a complete crack which is air filled. If the crack becomes filled with water or sand or if numerous contacts exist across the fracture plane, effective vibration reduction will not result.

e. Calibration of Site Vibration Levels. For effective ground vibration control, the propagation law constants H and β should be determined for each blasting site. These constants can be determined by measuring the three components of particle velocity at two or three distances for several blasts of different charge sizes. The charge size should be varied by changing the number of holes per delay interval. From these data, log-log plots of peak particle velocity for each component as a function of scaled distance are made as shown in Fig. 7-5. The data should group about a straight line. The slope of the line is β and the value of v at $D/W^{1/2} = 1$ is H . The values of H and β will, in general, be different for each component of peak particle velocity (radial, vertical, and transverse). After determining the values of H and β for one specific direction, additional data in other directions should be obtained to determine if the propagation law is the same for all directions from the blasting area.

7-4. Flyrock.

a. The high velocities and, consequently, great range of flyrock may be caused by particle acceleration resulting from escape of explosion gases and from spalling. Gas acceleration is considered to be dominant. If the rock mass contains weak zones, the explosion gases will tend to escape along these paths of least resistance, and thus may be concentrated in particular directions. Massive rock will tend to remain in large blocks that are merely loosened, while highly fractured rock is blown out at high velocities by the escaping gases.

b. Excessive flyrock from spalling is usually the result of an excessive charge for a hole or row of holes near the face. Flyrock can also be caused by loading individual holes too near the top. The velocity of spall-accelerated flyrock may be greater than that of gas-accelerated flyrock. This may account for anomalous rocks ejected to very great range.

c. Cratering experiments from high-explosive charges have provided some data on ranges of flyrock. Charges are usually completely contained (i.e. create no visible crater) at a depth (in feet) corresponding to about $3.5 W^{1/3}$, where W is charge weight (lb) of TNT or its equivalent.⁴⁹ From the standpoint of crater volume, the optimum charge depth is approximately $1.5 W^{1/3}$. Presumably, most quarry blasting will be accomplished at depths between these two extremes. Both spall and gas acceleration of ejecta have been observed for a limited number of cratering experiments in the near-optimum range, with the latter mechanism generally predominating. Fig. 7-6 illustrates the ranges of flyrock that have been observed from such experiments. Note that sixth-root scaling has been applied to these ranges; this scaling exponent is considered to be correct from both theoretical and practical aspects,^{50,51} and may be applied to the scaling of flyrock data obtained during site testing.

d. Ejection of flyrock is not necessarily reduced by decreasing the total weight of explosive, either for a conventional blast or a concentrated (point) charge detonation. The most effective method of controlling flyrock in conventional rock blasting operations is by good blasting design as discussed in Chapter 5. A thorough investigation of the rock structure to locate weaker rock, careful design of the pattern, and proper loading of the holes should result in an efficient blast with little or no flyrock. Heavy wire mesh mats spread on the bench and face to be blasted are commonly used as a means of control.⁵² In some cases, low-numbered, delayed holes are believed to have more tendency to fly than following delays. For this reason the instantaneous and lower number holes have sometimes been covered by blasting mats while succeeding holes were not.

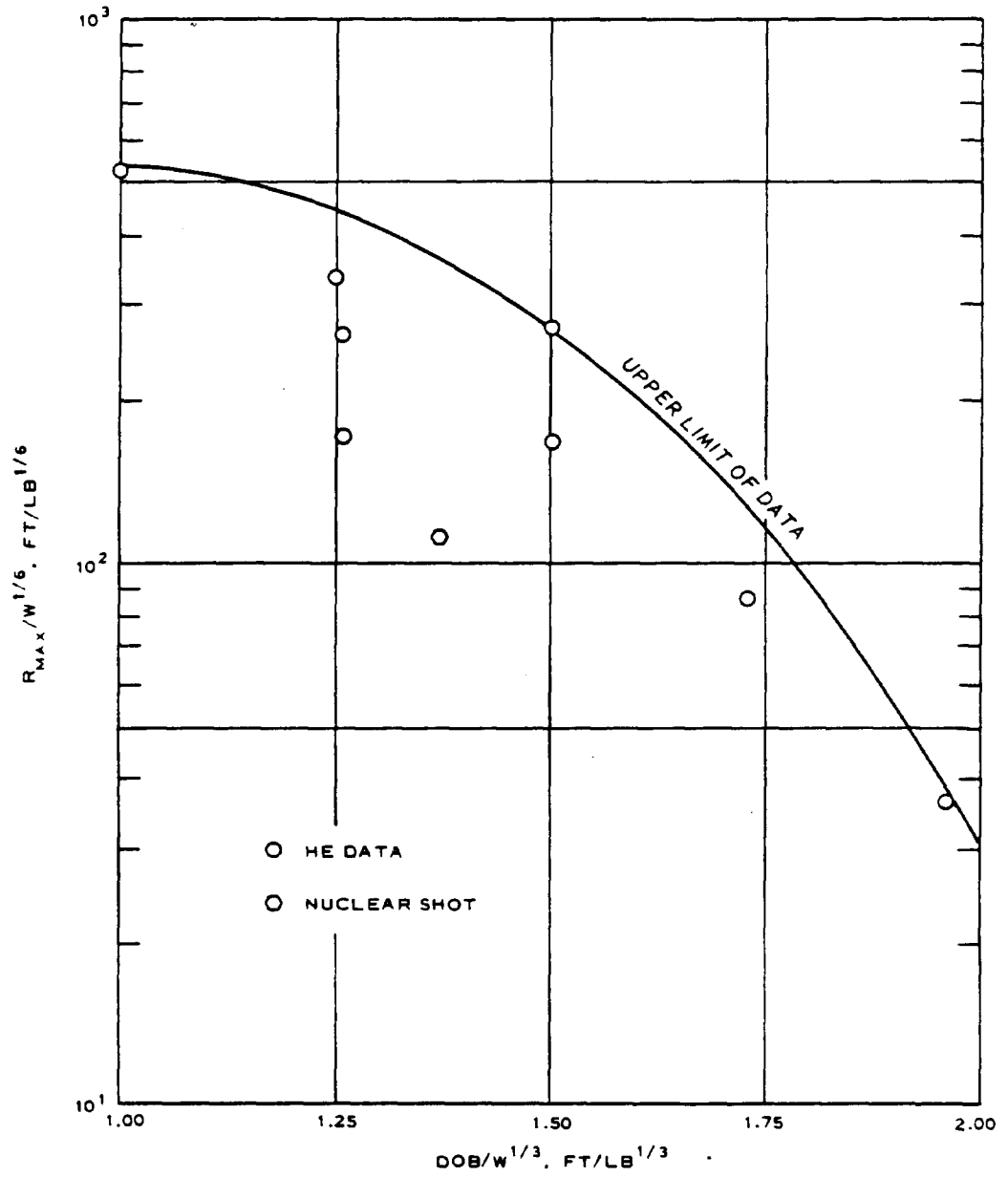

Fig. 7-6. Maximum observed ranges of natural missiles for buried explosions in basalt. Data are from a tabulation in ref 52

CHAPTER 8. DRILLING AND BLASTING IN ROCK EXCAVATION BY CONTRACT

8-1. General. The CE designs and supervises excavation projects necessitating drilling and blasting by contractor forces. Many of these excavations can tolerate only minimal blast effects on the rock mass immediately adjacent to the lines and grades. Such excavations are designed to be economical and yet to meet certain design criteria of the final installation. Elsewhere, the Government has an interest in fragmentation obtained in blasting rock, intended to be utilized for rock-fill embankments and slope protection. Successful economical completion can be accomplished, but it usually demands considerable effort in planning, design, and inspection.

a. Customary Contract Approach. It is customary in construction contracts that unit bid prices for the items "rock excavation," or in some cases "excavation unclassified," include all costs of drilling and blasting. If the rock outlining the excavation is to be protected, it is common practice to describe the results required of the excavation operation by statements in the specification to the effect that: (1) the explosives used shall be of such quality and power and shall be used in such locations as will neither open joints nor crack or damage the rock outside the prescribed limit of excavation, (2) as the excavation reaches final lines and grades, the depth of holes for blasting and the amount of explosives used per hole shall be progressively reduced, and (3) excavation that exceeds the prescribed tolerance of lines and grades will be backfilled with prescribed materials. Other restrictions or limitations may also be included. It is the responsibility of the contractor to select the methods and operate in a manner that will produce the required results. It is expected that a prudent contractor will include in his bid a contingency item based on his judgment of the difficulty of the required work. Some specifications go further and prescribe routine procedures such as presplitting. The degree of responsibility of the contractor for the success of these procedures depends to some extent on the latitude and options given the contractor in the manner of employing the procedures. This general industry-wide approach to rock excavation in contracts meets with varying degrees of success. Where the rock excavation required is essentially the removal of large quantities of rock exemplified by highway cuts, the unit price of rock excavation has remained relatively stable over the last decade. However, when rock excavation requiring more exacting results is considered, disputes and controversies are common and may lead to claims for additional cost.

b. Variation of Customary Approach. It is considered to be to the best interest of the Government to reduce the element of risk for the

contractor as far as practicable in bidding on Federal contracts. This is done in the effort to secure the most competitive bidding by reducing the contractor's need to add a contingency item for possible costs not specifically anticipated. There is evidence from CE projects that this approach is applicable to specifications regarding blasting. When there is sufficient knowledge from previous work and from geologic data to determine that certain blasting techniques, procedures, or limitations will probably be necessary to complete the work, this information should be included in the plans or specifications in some manner. Where it is essential that the final lines be obtained with close tolerances and the rock be undisturbed, the plans and specifications should outline in detail such requirements so the bidders can estimate accordingly. There is somewhat of a precedent to this approach in that the CE practice for Civil Works construction requires compaction of embankments on the basis of specified compaction procedures and moisture control, rather than on the basis of a required end product.

8-2. Considerations in Preparation of Plans and Specifications.

a. **Stated Principles of Plans and Specifications.** A general principle applicable to all CE contract plans and specifications is that they will be carefully prepared to eliminate all conditions or practices that might operate to delay the work or that might result in controversy (see ER 1110-2-1200, para 7a). Further, specifications should be so clear and complete that any competent manufacturer or construction firm should experience no undue difficulty in preparing bids or estimates. Questions that may arise during performance of the contract should be resolvable by reference to the contract, of which the specifications form a part (see ER 1110-2-1200, para 7d).

b. **Pertinent General and Special Provisions.** As rock excavation is not covered by guide specifications, recently approved and successful project specifications or sections thereof may be used as guides to the extent they are applicable. All technical provisions are subordinate, first, to the General Provisions and, second, to the Special Provisions of the general contract. The following is a list of those provisions that are deemed most pertinent to rock excavation; they should be reviewed and kept in mind during the preparation of plans and specifications.

General Provisions

- Clause 2—Specifications and Drawings
- Clause 3—Changes
- Clause 4—Changed Conditions
- Clause 6—Disputes
- Clause 9.b.—Materials and Workmanship

Clause 12—Permits and Responsibilities
Clause 14—Other Contracts
Clause 23—Contractor Inspection System
Clause 32—Site Investigations
Clause 34—Operations and Storage
Clause 39—Additional Definitions
Clause 40—Accident Prevention
Clause 41—Government Inspection
Clause 50—Value Engineering
Clause 62—Variations in Estimated Quantities

Special Provisions

Physical Data
Variation in Estimated Quantities—Subdivided Items
Layout of Work
Quantity Surveys
Damage to Work
Approved Material Sources
Payment
Authorized Representative of Contracting Officer
Contractor Quality Control

c. Geologic Data. Data developed from geologic investigations affect the design, preparation of plans and specifications, and the pricing placed on the required rock excavation by the contractors in bidding the work. The responsibility for presenting an accurate description of materials to be excavated rests with the Government. EM 1110-1-1801 and EM 1110-1-1806 should be consulted in this regard.

d. Review Plans for Practicality of Excavation Outlines. During preparation of plans and specifications, the design should be reviewed for the practicality and the degree of difficulty in obtaining the various excavation outlines. These should be considered as to the possibility of attainment compared with their probable cost. For example, exterior vertical corners at right angles may be eliminated and replaced by battered corners.

e. Construction Inspection To Be Expected. Reference should be made to paragraphs 2-27 and 103-03(d) in EP 415-1-261.

f. Blast Records. The specifications should require the contractor to furnish the Contracting Officer complete information on every blast. Where a proposed general blasting plan is required prior to the start of blasting, the individual blast reports may be submitted after

1 Mar 72

the blast. On other projects, proposed blast data have been required before drilling commences on each blast with a final report required after the shot is fired. Information should include location of blast by station and range; elevation of top of blast; depth, spacing, burden, number, and diameter of holes; type and quantities of explosives; quantities of detonating cord used; quantities and delay periods of electrical caps; maximum quantity of explosive detonated in a single delay period; a sketch of drill-hole pattern; number of cubic yards blasted; and powder factor. Fig. 8-1 shows one type of form provided to contractors by the Associated General Contractors of America, Inc. Fig. 8-2 illustrates a sample of a blast report form.

g. Sequence of Operations. Where there are technical reasons for excavation to proceed in a particular sequence, this requirement should be clearly defined in either the plans or specifications.

h. Specifying Methods—Obtaining Sound Walls. Where experience and geologic data indicate that a method such as presplitting is necessary to obtain the desired results, specify the method, or methods if an option can be given. Each method should be described in sufficient detail so that no item is omitted that might prove to be essential for its success. Allow enough latitude that the method can be adjusted to the field conditions and to contractor's proposals. Any contractor's proposal shall be described in detail and demonstrated to give equal and satisfactory results. When specifying presplitting, it is well to keep in mind that in some rocks, right-angle, outside corners of excavations are not too successfully obtained. Provisions for line drilling outside corners should be considered. Locally the burden in front of the pre-split wall will need to be blasted in small shots to a free face.

i. Obtaining Final Grade. The use of angle holes and limitation on the depth of a final lift should be considered if they will be helpful in obtaining the final grade without damaging the underlying rock.

j. Specifying and Prohibiting Certain Practices. It is sometimes beneficial to provide in the specification for the use of such measures as deck-loaded and small-diameter holes that may be deemed necessary later. Undesirable practices, such as subdrilling below specified tolerances in structural excavations, should also be prohibited.

k. Requiring Gradation Ranges in Blasted Rock. When blasting results are desired to produce certain fragmentation, test blasting should be performed by the contractor to demonstrate that he will produce the desired product. In certain rock types there is often

EXPLOSIVE SIZE **1 1/2" x 8"**
 EXPLOSIVE TYPE **40% - Gel Dupont**
 DELAY TYPE **M/5-1, 2, 3, 4**
 TYPE OF ROCK **Mica Schist**
 BLASTER **J. Jones**

Identify Job location by station or dimension to known structure or object. Show North Point.

BLAST STATION **0 + 50 on B Street**
 DATE **2-1-58** TIME **10:05 A.M.**
 DISTANCE TO NEAREST BUILDING **60'**
 DISTANCE OF THROW **None**
 DIRECTION OF WIND **N.W. temp 40°**
 WERE MATS USED? **Yes**

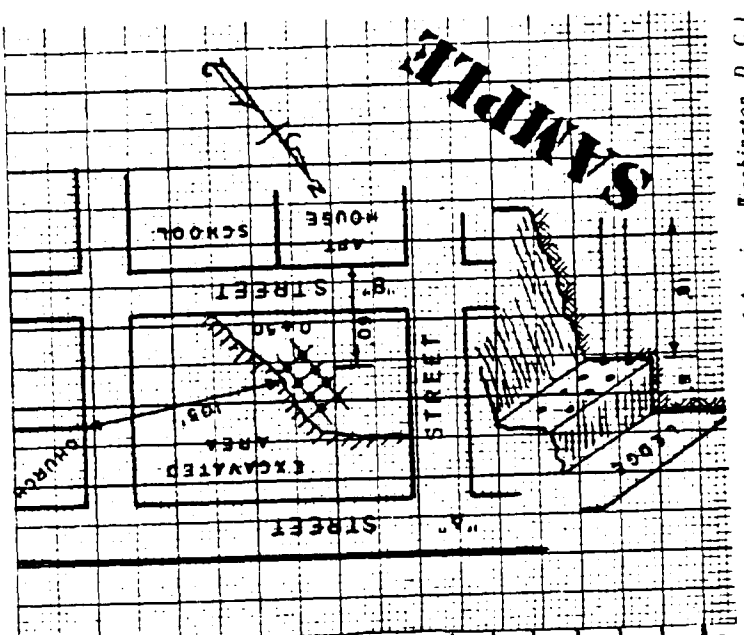

| HOLE NO. | HOLE DEPTH | DELAY NO. | NO OF STICKS | NO OF POUNDS |
|--------------|------------|-----------|--------------|--------------|
| 1 | 18' | 1 | 20 | 10 |
| 2 | 18' | 1 | 20 | 10 |
| 3 | 18' | 2 | 25 | 12.5 |
| 4 | 18' | 2 | 25 | 12.5 |
| 5 | 18' | 3 | 20 | 10 |
| 6 | 18' | 3 | 20 | 10 |
| 7 | 18' | + | 18 | 9 |
| 8 | 18' | + | 18 | 9 |
| 9 | | | | |
| 10 | | | | |
| 11 | | | | |
| 12 | | | | |
| 13 | | | | |
| 14 | | | | |
| 15 | | | | |
| TOTAL | | | | 89.0 |

(Courtesy of The Associated General Contractors of America, Washington, D. C.)

Fig. 8-1. Example of one form of blasting log kept by contractor

SHOT RECORD

SHOT NO _____

*DATE: _____

*PROJECT: _____ *TIME: _____

*CONTRACTOR: _____ SUB: _____

*PURPOSE OF BLAST: _____

DRILLING DATA

*LOCATION: _____ *STA: _____ TO _____

*RN: _____ TO _____

SURFACE ELEV: _____

BOTTOM ELEV: _____

GEOL FMT'S: _____

VOL: L _____ X W _____ X H _____ = _____ CY

*DRILL TYPE: _____ DRILL ANGLE: _____

*HOLE DIA: _____ SLOPE (FREE FACE): _____

*NO OF HOLES: _____ *DEPTH: _____ *PATTERN: _____

EXPLOSIVE DATA

*TOTAL AMT: ① _____ LBS *TRADE NAME: _____ *STN: _____ *SIZE: _____

② _____ LBS

③ _____ LBS

④ _____ LBS

POWDER FACTOR: ① _____ LB/CY ② _____ LB/CY ③ _____ LB/CY ④ _____ LB/CY

TOTAL: _____ LB/CY

DETONATORS:

*TYPE _____ DETONATING FUSE _____

*PERIODS: 1 1 2 3 4 5 6 7 8 9 10 11 12 13 14

*LOADING DIAGRAM:



SAMPLE

RESULTS

EXCAVATION METHOD: _____

QUANTITY OF ROCK PRODUCED: _____

*FRAGMENTATION: _____

PRE SPLIT RESULTS: _____

COMMENTS

*FURNISHED BY CONTRACTOR _____

SIGNED _____

INSPECTOR OR CONTRACTOR

Fig. 8-2. Sample record of blasting

1 Mar 72

considerable percentage of rock "wasted" in order to obtain required gradation. Allowance for this should be made when estimating quantities of rock necessary to produce the desired product.

1. Vibration and Damage Control. See EM 385-1-1.

FOR THE CHIEF OF ENGINEERS:

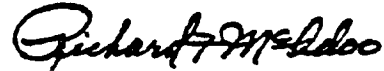

RICHARD F. McADOO
Colonel, Corps of Engineers
Executive

2 Appendixes

APP A - References

B - Typical CE Blasting Specifications

EM 1110-2-3800
1 Mar 72

APPENDIX A

REFERENCES

1. Atchison, T. C., "Fragmentation Principles," Surface Mining, American Institute of Mining, Metallurgical, and Petroleum Engineers, Inc., New York 1968, pp 355-372.
2. Rinehart, J. S., "Reaction of Rock to Impulsive Loads," Proceedings of the First Congress, International Society of Rock Mechanics, Vol 2, 1966, pp 105-109.
3. Atchison, T. C. and Pugliese, J. M., "Comparative Studies of Explosives in Granite: Second Series of Tests," Report of Investigations 6434, 1964, U. S. Bureau of Mines, Washington, D. C.
4. Lutton, R. J. and Girucky, F. E., "Project Sulky, Geologic and Engineering Properties Investigations," Report PNE-720, Nov 1966, U. S. Atomic Energy Commission; also published as Miscellaneous Paper No. 3-894, U. S. Army Engineer Waterways Experiment Station, CE, Vicksburg, Miss.
5. Paone, J., Unger, H. F., and Tandanand, S., "Rock Drillability for Military Applications," Contract Report (preliminary), 1968, Minneapolis Mining Research Center; prepared for U. S. Army Research Office, U. S. Bureau of Mines.
- †6. Dick, R. A., "Factors in Selecting and Applying Commercial Explosives and Blasting Agents," Information Circular 8405, 1968, U. S. Bureau of Mines, Washington, D. C.
7. Brown, F. W., "Determinations of Basic Performance Properties of Blasting Explosives," Quarterly, Colorado School of Mines, Vol 51, No. 3, July 1956.
- †8. Du Pont de Nemours (E. I.) and Co., Inc., Blasters' Handbook, 15th ed., Wilmington, Del., 1967.
9. Hughes Tool Co., "Scientific and Technical Applications Forecast; Excavation," 1964, Office of the Chief of Research and Development, Department of the Army, Washington, D. C.

Note: References indicated by dagger (†) are recommended for availability to and study by field construction personnel.

EM 1110-2-3800

APP A

1 Mar 72

10. Tandanand, S. and Hartman, H. L., "Stress Distribution Beneath a Wedge-Shaped Drill Bit Loaded Staticly," International Symposium on Mining Research, Vol 2, Pergamon Press, New York, 1962, pp 799-831.
11. Price, N. J., Fault and Joint Development in Brittle and Semi-brittle Rock, 1st ed., Pergamon Press, New York, 1966.
12. Lutton, R. J., "Comparison of Strengths of Dense and Vesicular Types of Basalt," Engineering Geology, Vol 6, 1968, pp 1-11.
13. Liljestrand, W. E., "Rotary Percussion Air Hammer Drilling," Quarterly, Colorado School of Mines, Vol 56, No. 1, Jan 1961, p 90.
- †14. Langefors, U. and Kihlström, B., The Modern Technique of Rock Blasting, Wiley, New York, 1963.
15. Babic, M. M., "Blasting by the BM Method," Mining and Minerals Engineering, Apr 1968, pp 19-27.
16. Kochanowsky, B. J., "Theory and Practice of Inclined Drilling for Surface Mining," Quarterly, Colorado School of Mines, Vol 56, 1961, pp 291-308.
17. "Planning a Big Blast," Engineering and Mining Journal, Vol 165, Nov 1964, pp 84 and 85.
- †18. Ash, R. L., "The Mechanics of Rock Breakage," Pit and Quarry, Vol 56, No. 3, Sept 1963, p 119.
19. Harley, W. L., "A Three-Tunnel Blast in a Wisconsin Quarry," The Explosives Engineer, July-Aug 1957, pp 121-125.
20. Chevkin, A. I., "Experience in Canal Construction Using Excavation by Explosives," Gidrotekhnika i Melioratsiia, No. 1, 1967, pp 64-69; English translation by M. E. Day, Translation No. 730, U. S. Bureau of Reclamation, Denver, Colo.
- †21. "Presplitting," Construction Methods and Equipment, Vol 46, June 1964, pp 136-141.
22. Veith, F. L., "Line Drilling and Presplitting," Pacific Builder and Engineer, Aug 1965, p 64.
23. Stenhouse, D., "Some Applications of the Presplitting Technique in

- Rock Blasting," Mining and Minerals Engineering, Dec 1967, pp 453-464.
24. Nichols, H. L., Jr., Moving the Earth; the Workbook of Excavation, 2d ed., North Castle Books, Greenwich, Conn., 1962, pp 8-43.
 - †25. Leet, L. D., Vibrations from Blasting Rock, Harvard University Press, Cambridge, 1960.
 26. Carroll, R. D., "Rock Properties Interpreted from Sonic Velocity Logs," Journal, Soil Mechanics and Foundations Division, American Society of Civil Engineers, Vol 92, No. SM2, Paper 4715, Mar 1966, pp 43-51.
 27. Deklotz, E. J., Brown, J. W., and Stemler, O. A., "Anistropy of a Schistose Gneiss," Proceedings of the First Congress, International Society of Rock Mechanics, Vol 1, 1966, pp 465-470.
 28. Nicholls, H. R. and Duvall, W. I., "Presplitting Rock in the Presence of a Static Stress Field," Report of Investigations 6843, 1966, U. S. Bureau of Mines, Washington, D. C.
 29. Iliev, I. G., "An Attempt to Estimate the Degree of Weathering of Intrusive Rocks from Their Physico-Mechanical Properties," Proceedings of the First Congress, International Society of Rock Mechanics, Vol 1, 1966, pp 109-114.
 30. Theonen, J. R. and Windes, S. L., "Seismic Effects of Quarry Blasting," Bulletin 442, 1942, U. S. Bureau of Mines, Washington, D. C.
 31. Kinney, G. F., Explosive Shocks in Air, MacMillan, New York, 1962.
 32. Mayes, W. H. and Edge, P. M., "Effects of Sonic Boom and Other Shock Waves on Buildings," Minerals Research and Standards, Nov 1964.
 33. Perkins, B., Jr., Lorrain, P. H., and Townsend, W. H., "Forecasting the Focus of Air Blast Due to Meteorological Conditions in the Lower Atmosphere," Report No. 118, Oct 1960, Ballistic Research Laboratories, Aberdeen, Md.
 34. Perkins, B., Jr., and Jackson, W. F., "Handbook for Prediction of Air Blast Focusing," Report No. 1240, Feb 1964, Ballistic

EM 1110-2-3800
APP A
1 Mar 72

Research Laboratories, Aberdeen, Md.

35. Langefors, U., Kihlström, B., and Westerberg, H., "Ground Vibrations in Blasting," Water Power, Feb 1958.
36. Edwards, A. T. and Northwood, T. D., "Experimental Studies of the Effects of Blasting on Structures," The Engineer, Vol 210, Sept 1960, pp 538-546.
37. Duvall, W. I. and Fogelson, D. E., "Review of Criteria for Estimating Damage to Residences from Blasting Vibrations," Report of Investigations 5968, 1962, U. S. Bureau of Mines, Washington, D. C.
38. Crandell, F. J., "Ground Vibration Due to Blasting and Its Effects upon Structures," Journal of the Boston Society of Civil Engineers, Apr 1949, pp 222-245.
39. Power, D. V., "A Survey of Complaints of Seismic-Related Damage to Surface Structures Following the Salmon Underground Nuclear Detonation," Bulletin of the Seismological Society of America, Vol 56, No. 6, Dec 1966, pp 1413-1428.
40. Goldman, D. E., "A Review of Subjective Responses to Vibrating Motion of the Human Body in the Frequency Range 1 to 70 Cycles per Second," Report No. 1, Project N. M. 004001, Mar 1948, Naval Medical Research Institute.
41. Engineering Research Associates, Inc., "Underground Explosion Test Program; Granite and Limestone," Technical Report No. 4, Vol 1, Aug 1952, St. Paul, Minn.
42. _____, "Underground Explosion Test Program; Sandstone," Technical Report No. 5, Vol 1, Feb 1953, St. Paul, Minn.
43. Duvall, W. I. and Atchison, T. C., "Rock Breakage with Confined Concentrated Charges," Mining Engineering, Vol 11, June 1959, pp 605-611.
44. Nicholls, H. R., Hooker, V. E., and Duvall, W. I., "Dynamic Rock Mechanics Investigations," Report on Project Cowboy, 1960, U. S. Bureau of Mines, Washington, D. C.
45. Duvall, W. I., "Design Criteria for Portable Seismographs," Report of Investigations 5708, 1961, U. S. Bureau of Mines, Washington, D. C.

46. Duvall, W. I., "Design Requirements for Instrumentation to Record Vibrations Produced by Blasting," Report of Investigations 6487, 1964, U. S. Bureau of Mines, Washington, D. C.
47. Duvall, W. I. et al., "Vibrations from Instantaneous and Millisecond-Delayed Quarry Blasts," Report of Investigations 6151, 1963, U. S. Bureau of Mines, Washington, D. C.
48. Devine, J. F. et al., "Effect on Charge Weight of Vibration Levels from Quarry Blasting," Report of Investigations 6774, 1966, U. S. Bureau of Mines, Washington, D. C.
49. Strange, J. N., Denzel, C. W., and McLane, T. I. III, "Cratering from High Explosive Charges; Analysis of Crater Data," Technical Report No. 2-547, Report 2, June 1961, U. S. Army Engineer Waterways Experiment Station, CE, Vicksburg, Miss.
50. Chabai, A. J., "Scaling Dimensions of Craters Produced by Buried Explosions," Research Report SC-RR-65-70, Feb 1965, Sandia Corporation, Albuquerque, N. Mex.
51. Vortman, L. J., "Maximum Missile Ranges from Surface and Buried Explosions," Research Report SC-RR-67-616, Sept 1967, Sandia Corporation, Albuquerque, N. Mex.
52. Canadian Industries, Ltd., CIL Blasters Handbook, Montreal, Canada, 1955.

APPENDIX B

TYPICAL CE BLASTING SPECIFICATIONS

1-1. Introduction. Paragraphs 1-2, 1-3 and 1-4 below are examples of typical actual construction specifications on blasting for large structures and roadcuts. Only the portions pertaining to blasting have been extracted. The fourth example (par. 1-5) specified seismic monitoring for vibration and damage control at a large quarry.

1-2. Blasting Specifications for Spillway and Intake Structure (in Andesite and Tuff Breccia), Blue River Dam.

SECTION 3. EXCAVATION

3-04. EXCAVATION FEATURES.

j. Excavation, Intake Structure. - (1) A prism of rock not less than 15 feet wide adjacent to the walls of the intake structure above elevation 1150 shall be drilled and blasted in lifts not exceeding 20 feet in depth only after removal of the interior portion of the channel.

(2) A prism of rock not less than 15 feet wide adjacent to the face forming the tunnel portal shall be excavated only after removal of the interior portion of the channel. Above elevation 1160 the blasting lifts shall not exceed 20 feet in depth. Below elevation 1160 the blasting lifts shall not exceed 10 feet in depth. All blast holes in the rock prism adjacent to the portal slope shall be deck loaded or loaded with explosives on a detonating cord and delayed in a pattern and sequence that will prevent back-pressure and damage to final faces. Presplit blasting shall be used along the portal face down to elevation 1160. Below elevation 1160 "Line Drilling" shall be used along the portal face and along each end of the rock prism adjacent to the portal slope. "Line Holes" shall not be more than one hole diameter apart and shall not be loaded with explosives.

k. Excavation, Spillway Channel. - The 20-foot-wide zone of rock adjacent to each of the two channel walls shall be excavated only after removal of the interior portion of the channel excavation. In addition to presplit blastholes along the final slopes, the width of lifts and the pattern and

sequence of detonating blast holes shall be such that will prevent back-pressures and damage to final faces and configuration.

3-05. EXPLOSIVES. - a. Safety. - In addition to full compliance with Section XXII, Blasting, of General Safety Requirements, EM 385-1-1, dated 13 March 1958.†

b. Storage. - The Contractor shall submit to the Contracting Officer, for approval, drawings showing the location, access to and type of construction of the proposed storage magazine for explosives, and cap house. The explosives storage magazine and other facilities may be located on Government lands if satisfactory locations can be found and are approved by the Contracting Officer; or the Contractor, at his option, through private negotiations, may locate explosive magazines outside Government lands. The Contractor shall provide and maintain access to the explosive storage areas at his own expense.

3-06. DRILLING AND BLASTING. - a. General. - The drilling and blasting program and methods shall be those necessary to accomplish the excavation shown on the contract drawings in accordance with the procedure specified herein. Under no circumstances shall blasting be performed within 100 feet of concrete which has been placed less than seven days. Blasting within 100 feet of concrete older than seven days will be permitted only if approved by the Contracting Officer. A 50-watt, remote-controlled radio transmitting tower owned and operated by the Forest Service is located near the auxiliary dam as indicated on the drawings. Necessary precautions to avoid a premature blast due to operation of the transmitter shall be taken by the Contractor.

b. Blasting. - Prior to drilling for each blast, unless excepted by the Contracting Officer, the Contractor shall submit on an approved form the pertinent data on the location, depth and area of the blast; diameter, spacing, depth, overdepth, pattern and inclination of blast holes; the type, strength, amount, distribution and powder factor for the explosives used per hole and per

† The manual has subsequently been revised and issued 1 Mar 1967.

blast; the sequence and pattern of delays, and description and purpose of special methods. The loading of holes shall be done in the presence of a Government inspector. Acceptance by the Contracting Officer of blasting data will not relieve the Contractor of his responsibility to produce satisfactory results as set forth in these specifications. Drilling and blasting shall be done only to the depth, amount and at such locations, with explosives of such quantity, distribution and density that will not produce unsafe or damaged rock surfaces or damage rock beyond the prescribed excavation limits. Excavation for this contract has rock with vertical and lateral variations in hardness and texture containing open and oxidized seams, shear planes, joints and faults. As excavation operations progress, the drilling and blasting procedures shall be determined only by satisfactory results achieved, and approved by the Contracting Officer. When a drilling and blasting program results in damage to the excavation, the Contractor will be required to devise and employ methods which will prevent such damage. The revision may include special methods such as presplit and zone blasting, shallow lifts, reduction in size of individual blasts, small diameter blast holes, closely spaced blast holes, reduction of explosives, greater distribution of explosives by use of decking and primacord or variation in density of explosives.

c. Presplit Blasting. - (1) General. - The presplit method of blasting is defined as the use of an optimum quantity of explosives, distributed along primacord the full hole depth and detonated so as to produce an open shear plane between closely spaced blast holes prior to the adjacent primary blasting. This method shall be used for all faces or slopes steeper than 1 on 1.

(2) Open Cut Excavation. - Presplit blast holes shall be detonated prior to drilling and blasting of the adjacent rock. Test blasts may be used in the areas of varying slope and rock conditions. However, the spacing of loaded presplit blast holes shall not exceed 24 inches center to center, and may be as close as 12 inches. Blast holes in areas of total confinement may be drilled to the full depth of the excavation; however, in some areas with open faces the depth of blast holes may be limited and will not exceed the horizontal burden. The hole diameter shall be at least two times the diameter of the explosive cartridge. The amount

of explosives in blast holes having a slope flatter than one on one-third shall be reduced progressively with the flattening of slope. The depth of stemming above the explosive will be kept to a minimum and shall not exceed one-fourth of blast hole depth. Stemming may be required between each explosive charge in areas where rock contains open, weathered, or clay-filled seams, joints or faults.

d. Structures. - Excavation of slopes, faces and shapes in the foundation for structures may necessitate, in addition to presplit blasting, the use of full hole decking, limitation on the depth of blast holes, and a limitation on the width of blast area adjacent to final surfaces to prevent structural damage to rock beyond the excavation lines. The method and type of blast hole decking and hole spacing will be determined by results which are satisfactory to the Contracting Officer.

e. Berms, Benches, Faces and Structural Forms. - Where a berm, bench or other horizontal surface superimposes a vertical or sloped surface, excavation to line and grade of the horizontal surface shall be completed prior to starting excavation of the vertical or sloped surfaces in order to prevent loss of the berm shoulder or damage to the underlying rock face. Blast holes shall not be drilled to a depth greater than 2 feet below the design grade of a berm. Drilling and blasting lift depths in confined shapes or features shall be limited from one-half to two-thirds the excavation width unless otherwise approved by the Contracting Officer.

f. Final Grades and Excavation Lines. - When excavation has progressed to within 15 feet of the final grade or lines of required excavation against which concrete is to be placed, drilling and blasting shall be limited to two-thirds of the remaining depth of excavation except that when 5 feet or less of rock remains to be excavated, blasting may be permitted to final grade if it can be demonstrated that no damage will result to the foundation. Blast holes larger than 3-1/2 inches in diameter shall not be drilled closer than 5 feet to a horizontal or near horizontal grade or within 15 feet of a vertical or near vertical face. Whenever, in the opinion of the Contracting Officer, further blasting may injure the rock upon or against which concrete is to be placed, the use of explosives shall be discontinued and the excavation

shall be completed by hand methods and/or pneumatic tools, by wedging, barring, picking or other approved methods exclusive of explosives.

1-3. Blasting Specification for Structure Area (in Limestone), Stockton Dam.

SECTION B2. EXCAVATION

B2-05. Spillway-Powerhouse Area Excavation. a. General.

(1) Spillway-powerhouse area is identified as the areas which are prepared for the concrete structure and includes the approach and outlet channel.

(2) Structure area is identified as that portion of the spillway-powerhouse area from dam station 99+84 to dam station 106+48, range 0+90 upstream to range 4+12 downstream.

B2-08. Lines, Grades, and Tolerances. a. General. Unless otherwise specified, all excavation shall be completed to the lines and grades shown on the drawings.

b. "A" and "B" lines as shown on the drawings indicate the maximum and minimum limits for "Bearing Surfaces" and "Special Surfaces." No material will be permitted to remain inside the "A" lines.

c. Tolerances. (1) "Special Surfaces" are presplit rock surfaces (except 1 on 1.5 spillway apron slope) against which concrete is to be placed. The tolerances are the "A" lines to "B" lines.

(2) "Bearing Surfaces" are all surfaces under concrete structures which are not defined as "Special Surfaces." Tolerances are the "A" lines to "B" lines.

(3) Presplit Surfaces (Other than "Special Surfaces"). Tolerances from the surfaces shown on the drawings shall not exceed three feet measured horizontally, however, the maximum horizontal tolerance between adjacent presplit holes shall not exceed twelve inches.

B2-09. Care of Water.

c. Structure Area. The ground-water level shall be lowered in advance of excavation to permit excavation in the dry and to minimize the water in the presplit blast holes and the presplit fracture. Not less than twenty days before the rock excavation reaches elevation 770, calyx holes 1, 2, and 3 shall be thoroughly cleaned out and dewatering started. The water level in the calyx holes shall be lowered to and maintained at a level within 5 feet above the bottom of the holes until excavation is completed. The Government reserves the right to use the calyx holes for observations. Calyx holes 1 and 3 shall be backfilled with lean concrete as directed and calyx hole 2 shall be treated as shown on the drawings. Lean concrete is specified in Division A, section CONCRETE, GENERAL.

d. The Spillway-Powerhouse Area. Excavation shall be performed in the dry.

B2-10. Blasting. a. General. All blasting in the spillway-powerhouse area outside of the structure area and in the quarry for rockfill shall be designed to produce the maximum amount of material suitable for rockfill zones and to minimize the quantity of grizzly fines. No blasting shall be allowed within 100 feet of concrete or grout which has an age less than 7 days nor within 50 feet of any concrete or grout regardless of age. It was found in blasting for rockfill in quarry No. 2 during Stage I Construction that the use of low density powder produced the best results, as the quantity of grizzly fines was substantially reduced. As "Special Surfaces," "Bearing Surfaces," other presplit surfaces, and other final surfaces are approached, blasting shall be carefully controlled to avoid damage to these surfaces. Initial drilling and blasting in any area or type of rock shall be limited to a maximum production of 2,000 cubic yards per shot until the method is proven to produce the specified results. Subsequent drilling and blasting in required excavations shall be limited to a maximum production of 6,000 cubic yards per shot in the Spillway Powerhouse Structure Area. In "Spillway-Powerhouse Excavation - Rock" and "Quarry Excavation-Rock" the size of the shot may be increased in increments up to 3,000 cu. yds. provided the fragmentation and clay content of the excavated material is and continues to be satisfactory. The maximum

size of production shall be limited to 20,000 cu. yds. per shot. All muck in front of any face being shot including the structure area shall have been removed before the round is fired. The use of millisecond delays is not initially restricted; however, should proper fragmentation not be obtained, or if overfragmentation produces excessive fines or incipient fractures in the rock to be used for "Rock Zone 2" and "Rock Zone 3," the Contracting Officer reserves the right to prohibit the use of millisecond delays and to require the use of regular delays. Drilling equipment must be capable of efficiently drilling blast holes from 2 inches to 5 inches in diameter. The manner in which the rock breaks as excavation progresses will be observed and if the specified results are not obtained, the Contractor will be required to revise his operation as necessary. The blasting operation shall not be revised without the prior approval of the Contracting Officer. The Contractor shall keep records of each blasting shot (round) including the following information: date, station and range, lift, number of holes, hole size, consecutive shot number, spacing, and depth; kind of explosive, quantity and method of loading and firing; delays; fragmentation range, and percent of grizzly fines. A copy of the records shall be furnished the Contracting Officer after each round.

b. Structures. In the structure area blasting of the 20-foot wide protective bench and the lift immediately above the bearing surface as shown on the drawings, shall be accomplished using blast holes (inclined with the bottom pointing 20° to 30° from the vertical in a downstream direction). No holes shall be closer than four feet to adjacent "Special Surfaces." A slow velocity powder in the range of 5,500 feet per second shall be used in the angle holes. Bolting of "Special Surfaces" and anchoring is specified in Division B, section ROCK BOLTS, ANCHOR BARS, AND DRAPED FENCING.

c. Presplitting. All rock surfaces 1 on 1.25 or steeper and the 1 on 1.5 spillway apron slope shall be presplit. All rock surface slopes 1 on $3/4$ or steeper shall be presplit prior to the time that horizontally adjacent material within 50 feet is drilled for blasting. Spillway apron shall be presplit lift by lift whenever the distance measured at the bottom of the lift is approximately 50 feet horizontal distance from the final surface. Depth of presplitting shall be limited to 33 feet on "Special Surfaces" elsewhere to

1 Mar 72

depths that Contractor demonstrates that tolerances can be maintained. Presplit surfaces shall be developed to at least three feet below the floor of a bench before the bench is blasted, except that the bottom bench shall be presplit to grade. General method of presplitting consists of drilling a line of holes spaced 24 inches (48 inches for "Spillway - Powerhouse Excavation - Rock") apart in the prescribed plane, loading all of these holes with an optimum amount of Trimtex or approved equal explosive, and detonating with Primacord or an approved equal detonating fuse. Results will be judged by the condition of the finished surface on which shall remain at least 70% of the length of casts for each of the presplit drill holes. No presplitting shall be done in the structure area until it has been demonstrated elsewhere that the techniques proposed obtain the specified results. Outside the structure area presplit lines shall be limited to 100 feet in length for each of the various slopes until it has been demonstrated that the technique produces the specified results.

B2-11. Excavation - Structure Area. a. Sequence of Excavation. Excavation shall be carried out in lifts as indicated on the drawings, and shall proceed in an upstream direction. A blasted "V" notch or stress relief slot as shown on the drawings shall be completed for each lift before drilling for primary blasting is done. Once a lift is started, it shall be carried to its final surface over its entire area before starting the next lift. Since the preservation of horizontal and vertical corners is critical, the presplitting of the protective bench shall be coordinated with the preset bolting as shown on the drawings and specified in Division B, section ROCK BOLTS, ANCHOR BARS, AND DRAPED FENCING. The 20-foot wide protective bench shall be shot after the muck from the adjacent primary blast has been removed. Rock bolting (other than preset bolts) as specified, and indicated on the drawings shall be completed within 24 hours after the protective bench is blasted.

b. Overexcavation and Backfill. Overexcavation because of a weakness inherent in the natural undisturbed structure of the bedrock shall be performed as directed, and the theoretical lines and grades will be adjusted accordingly. Material outside the excavation limits which are disturbed due to the fault or negligence of the Contractor or due to his failure to exercise sound engineering or

construction practices, shall be either replaced by him with suitable materials (earth or concrete), or bolted, or both as directed, at no cost to the Government.

1-4. Blasting Specifications for Roadcuts (in Basalt), Foster Regulating Reservoir.

3-04. EXPLOSIVES. - General. - In addition to full compliance with Section XXII, Blasting, of General Safety Requirements, EM 385-1-1, dated 13 March 1958. The Contractor shall submit to the Contracting Officer, for approval, drawings showing the location, access thereto and type of construction of the proposed storage magazine for explosives, cap house and "make up shack." The explosives storage magazine and other facilities may be located on Government lands if satisfactory locations can be found and are approved by the Contracting Officer; or the Contractor, at his option, through private negotiations, may locate explosive magazines outside Government lands. The Contractor shall provide and maintain access to the explosive storage areas at his own expense. In the use of explosives, the Contractor shall exercise the utmost care not to endanger life or property. The Contractor shall use methods and programs which will prevent damage to adjacent landscape features and which will minimize scattering of rock, stumps or other debris outside the finished roadway slopes. The Contractor will be responsible for any and all damage and/or injury resulting from the use of explosives.

b. Blasting. -

(1) The drilling and blasting methods and program shall be those necessary to accomplish the excavation shown on the contract drawings in accordance with the procedures specified herein. Explosives shall not be used as a primary means of transporting material outside the excavated prism.

(2) Prior to drilling for each blast, unless excepted by the Contracting Officer, the Contractor shall submit on an approved form a plan showing the location, size, spacing and depth of holes, blast hole loading, sequence and pattern of delays and special methods. Acceptance by the Contracting Officer of the blasting data will not relieve the Contractor of his responsibility to produce safe and satisfactory results as set forth by these specifications.

(3) Excavation for this contract has rock with vertical and lateral variations in hardness and texture, containing open and weathered seams, shear planes, joints and faults.

(4) Drilling and blasting shall be done only to the depth, amount and extent and with explosives of such quality, quantity and in such location that will neither disrupt nor damage the rock forming the prescribed limits of the excavation. When in the opinion of the Contracting Officer, damage is being done to the rock outside of the limits of the excavation, it will be the Contractor's responsibility to determine and use drilling and blasting methods that will produce the specified results regardless of the rock conditions encountered. Presplit Blasting shall be used to produce all slopes in rock excavation not ripped and which are more than 10 feet deep. The presplit method of blasting is defined as the use of an optimum quantity of explosives distributed along a detonating cord the depth of the blast hole so as to produce an open shear plane between closely spaced blast holes prior to blasting the adjacent rock. This method shall be used on all slopes steeper than 1 on 1 and shall be used the full depth of the rock excavation. Test blasting may be used in areas of varying slope and rock conditions. The presplit blast hole diameter shall be at least two times the diameter of the explosive cartridge. The holes shall be drilled parallel to the slope of the designed excavation and shall have a spacing not to exceed 30 inches but may be as close as 24 inches. Center to center holes in areas of total confinement may be drilled to the full depth of the excavation, however, in areas with open faces the depth of blast holes may be limited and will not exceed the horizontal burden. The blasting shall be accomplished by loading the holes with string charges of 40 percent gelatin dynamite attached to a detonating cord, so that all charges shall be uniformly spaced throughout the length of the hole.

Charges will not exceed 1/4 pound of dynamite per linear foot of depth. In addition, one pound of dynamite shall be concentrated at the bottom of the hole. The amount of explosives in blast holes having a slope flatter than one on one-half will be reduced progressively with the flattening of slope. Holes shall be stemmed with coarse sand or free-running gravelly sand having a maximum size of 3/8-inch. The depth of stemming shall be kept to a minimum and shall not exceed

one-fourth the blast hole depth. Stemming may be required between each explosive charge in areas where the rock contains open seams, joints or faults. Pre-split blast holes shall be detonated prior to drilling and blasting the adjacent rock except when conditions will not permit this method or when it can be demonstrated to the satisfaction of the Contracting Officer that in special cases a millisecond delay system will produce acceptable rock surfaces.

1-5. Seismic Monitoring Specifications, Milton Freewater Quarry.

3-03. BLASTING FOR QUARRY OPERATIONS.

a. General: All blasting operations shall be performed in accordance with the applicable provisions of Corps of Engineers Manual EM 385-1-1 dated 13 March 1958, entitled "General Safety Requirements" and supplemented by North Pacific Division Supplement, dated 15 July 1960. The Contractor shall furnish to the Contracting Officer prior to each blast a plan of all blast holes showing pattern and depth of drilling, type of explosive used, loading pattern, and sequence of firing. This plan shall show all holes, charges and existing quarry face relative to quarry boundaries by dimensions and elevations in feet. The drilling and blasting plan is for record purposes only, and will not absolve the Contractor of his responsibility for using proper drilling and blasting procedures. If the Contractor selects and operates a quarry within one mile of any residence, building or bridge subject to vibration damage by blasting, the Contractor's blasting operations shall be subject to the requirements of paragraphs 3-03 b. and 3-03 c., below.

b. Monitoring: All blasting for quarry operations that are within one mile of any residence, bridge, or building shall be monitored for each blast. No separate payment will be made for blasting or monitoring blasts in the riprap quarry, and all costs thereof shall be incidental to and included in the applicable Item No. 7, "Riprap, Class I," Item No. 8, "Riprap, Class II," or Item No. 9, "Riprap, Class III." For the initial blast of the quarry, the quantity of explosive shall be limited to an amount which will not cause damage to buildings, bridges, or private property in the area. When ground characteristics for any specified

blasting location have been determined from the initial blast by instrumentation, the allowable quantity-distance relations between the amount of explosives used and the distance from the blast site shall be determined from the accepted results of instrumentation at the given operation for the various weights of explosives. The vibration measurements at the nearest building or dwelling shall not exceed a total Energy Ratio of 1.0. Recordings shall be taken at all of the most critical locations. The Energy Ratio in a single direction shall be calculated by the following formula:

$$E.R. = (3.29 FA)^2$$

where F = frequency in cycles per second

A = amplitude in inches

Total Energy Ratio is defined as arithmetical sum of Energy Ratios in three mutually perpendicular planes of motion. Reference: Safety Regulation No. 23, dated 20 August 1965, State of New Jersey, Department of Labor and Industry, Trenton, New Jersey.

c. Seismograph: The Contractor shall have a minimum of two approved seismograph instruments for monitoring blasting operations (see exception, paragraph 3-03a). Additional instruments will be required if found necessary. Locations of instruments shall be subject to the approval of the Contracting Officer. Seismographs for monitoring of quarry blasting shall be placed at opposite locations. Each seismograph instrument shall be capable of recording photographically all three components of ground motion. The recorded data shall include for each shot:

- (1) Identification of instrument used.
- (2) Name of qualified observer.
- (3) Name of qualified interpreter.
- (4) Distance and direction of recording station from area of detonation.
- (5) Type of ground at recording station.

- (6) Maximum amplitudes for all components, as well as resultant for all recorded frequencies of vibrations.
- (7) Duration of motion in excess of one-one thousandth of an inch.
- (8) Frequency of ground motion in cycles per second.
- (9) Maximum energy ratio.
- (10) A copy of photographic records of seismograph readings, dated.
- (11) Recorded data from each blast, including the computed energy ratio shall be furnished to the Contracting Officer prior to the next succeeding blast.

INDEX

- Absorbent, 3-9, 3-10
 Adobe blasting, 5-14
 Aggregate, 5-24-5-25
 Airblast, 7-1-7-4
 Air waves, 2-1
 Aluminized slurry, 3-19
 Ammonia:
 dynamite, 3-10, 3-11, 3-12-3-13
 gelatin (special, extra), 3-14, 3-15, 3-16
 Ammonium:
 nitrate, 3-9, 3-10, 3-12, 3-13
 nitrate-fuel oil (ANFO), 3-16
 Antacid, 3-7, 3-9, 3-10
 Attenuation, 2-3

 Bedding, 6-9
 Bench blasting, 5-4-5-12
 Black powder, 3-9, 3-20-3-21
 Blast-fractured zone, 2-2, 2-3
 Blasting:
 agents (nitrocarbonitrates), 3-6-3-18
 cap, 3-21-3-24
 coefficient, 2-4, 6-4
 damage, 2-1, 7-1-7-18
 gelatin, 3-13, 3-14, 3-15
 Blast records, 8-3-8-4, 8-5-8-6
 Blockholing, 5-24
 Booster, 3-19
 Bulk strength, 3-1
 Burden, 5-1, 5-4

 C-3, 3-20
 C-4, 3-20
 Calcium carbonate, 3-9
 Cap and fuse, 3-22, 3-23
 Carbon monoxide, 3-7
 Cartridge:
 count, 3-2, 3-3
 strength, 3-1-3-2, 3-3, 3-4
 Cavities, 6-14-6-15
 Chalk, 3-9
 Characteristic impedance, 6-2-6-4
 Charcoal, 3-9
 Charge diameter, 3-4-3-5
 Chipping, 4-1
 Churn drills, 4-8, 4-11
 Combustibles, 3-9
 Composition B, 3-20
 Compressional wave, 2-3
 Compressive strength, 2-3, 2-4, 6-4
 Confined velocity, 3-5
 Conical bit, 4-1
 Contracts, 8-1-8-7
 Controlled blasting, 5-15
 Covote blasting, 5-12-5-13, 5-24, 5-26
 Cratering, 5-13, 7-17
 Crawler drill, 4-11, 4-12
 Critical diameter, 3-5
 Crushed zone, 2-2, 2-3
 Crushing, 4-1
 Cushion blasting, 5-21
 Cyclotrimethylenetrinitramine (RDX), 3-20

 Decked charges, 3-23, 5-4, 7-16
 Decoupled charges, 2-3, 6-14
 Deilagrations, 3-1
 Degree of confinement, 3-4, 3-22

 Delay:
 electric blasting cap, 3-21-3-22
 patterns, 5-3
 Density of explosives, 3-4, 3-5
 Detonating fuse, 3-21, 3-22-3-24
 Detonation, 3-1
 pressure, 3-5-3-7
 velocity, 3-1, 3-4-3-5, 3-6
 Detonator, 3-21-3-24
 Diamond bit, 4-4-4-5, 4-7
 Dipping strata, 6-14
 Displacement seismograph, 7-11-7-12
 Ditching dynamite, 3-10
 Down line, 3-23
 Down-the-hole drill, 4-8, 4-14
 Drag bit, 4-5
 Drifters, 4-8
 Drill bits, 4-1, 4-4-4-8
 Drill systems, 4-1, 4-4
 Dry blasting agents, 3-17-3-18
 Dynamite, 3-10-3-13

 Elastic waves, 2-1
 Electric blasting cap, 3-21-3-22, 3-23
 Ethylene glycol dinitrate, 3-9
 Explosion cavity, 2-2
 Explosive, 2-1, 3-1
 base, 3-7, 3-9
 charge distribution, 5-11, 5-12
 Extra dynamite, 3-10, 3-11, 3-12-3-13

 Fabric, 6-4, 6-7, 6-11-6-12
 Fault breccia, 6-9-6-11
 Faults, 6-9
 Ferrosilicon, 3-16
 Flyrock, 7-17-7-18
 Fragmentation, 2-2, 5-24
 Free face, 2-3
 Fuel oil, 3-9
 Fume class, 3-7

 Gelatins, 3-13-3-16
 Grade, 3-13
 Ground:
 coal, 3-9
 vibrations, 7-5-7-16
 Groundwater, 6-16
 Guar gum, 3-19
 Guide holes, 5-20

 Hammer:
 bits, 4-8-4-10
 drills, 4-8-4-15
 Hemispherical bit, 4-1
 High-density ammonia dynamite, 3-10, 3-11, 3-12
 High explosive, 3-1
 High velocity gelatin, 3-15
 Hole array, 5-1-5-4
 Hoop stresses, 2-3
 Horizontal presplitting, 5-20

 Inclined blastholes, 5-5
 Ingredients of explosives, 3-7, 3-9, 3-10

 Jackhammers, 4-8, 4-9, 5-23
 Jet-piercing, 4-1

EM 1110-2-3800

Index

1 Mar 72

INDEX (Cont'd)

- Jetty stone, 5-24
- Joint coating, 6-7, 6-8
- Jointing, 6-4, 6-7
- Joint orientation, 6-7, 6-8-6-9

- Kieselguhr (diatomite), 3-2, 3-9

- Lampblack, 3-9
- Lead azide, 3-9
- Lifter, 5-6, 5-8
- Line drilling, 5-21, 5-22-5-23
- Liquid oxygen explosive (LOX), 3-9
- Low-density ammonia dynamite, 3-11, 3-12-3-13
- Low-energy detonating cord (LEDC), 3-24
- Low explosive, 3-1

- Mechanics of drilling, 4-1, 4-4
- Mercury fulminate, 3-9
- Metallic powder, 3-9
- Microphone, 7-4
- Millisecond:
 - connector, 3-23-3-24
 - delay, 3-22, 7-13
- Mudcapping, 5-24

- Nitrocellulose (guncotton), 3-9
- Nitrogen oxide, 3-7
- Nitroglycerin, 3-9
- Nitrostarch, 3-9

- Oil well explosive, 3-13
- Oxygen carrier, 3-7

- Paraffin, 3-9
- Particle size, 3-4
- Peak particle velocity, 7-5
- Peak pressure, 2-1
- Pentaerythritol tetranitrate (PETN), 3-9, 3-21
- Pentolite, 3-20
- Percussive drills, 4-8-4-14
- Permissible explosive, 3-20
- Piezoelectric pressure gage, 7-4
- Plug bits, 4-4
- Pneumatic loading, 3-18
- Porosity, 6-4, 6-6
- Powder factor, 5-4, 6-4, 6-5
- Power augers, 4-5, 4-8
- Presplitting, 5-15-5-19, 6-7, 6-12, 7-16
 - corners, 5-20, 5-21
- Prill, 3-17
- Primary waves, 2-1
- Primer, 3-16, 3-21
- Prismatic bit, 4-1
- Pyramidal bit, 4-1

- Quarrying, 5-23-5-26, 6-1, 6-12

- RDX (cyclotrimethylenetrinitramine), 3-20

- Riprap, 5-24
- Rock fills, 5-25-5-26
- Roller bit, 4-4, 4-6
- Rotary drills, 4-3-4-8, 4-11, 4-14-4-15
- Rotary-percussive drill, 4-11, 4-14-4-15

- Safety, 1-1-1-2
- Scaling, 5-15
 - factor, 7-4
- Seismic:
 - explosive, 3-15
 - velocity, 6-1-6-2
 - zone, 2-2
- Seismograph, 7-12
- Semigelatin, 3-14, 3-16
- Sensitivity, 3-7
- Shaped charges, 3-20
- Shear waves, 2-1
- Slow delay, 3-22
- Slurry:
 - blasting agent, 3-19
 - boosting, 3-19
- Snake hole, 5-6, 5-7, 5-8
- Sodium:
 - chloride, 3-9
 - nitrate, 3-9
- Spacing, 5-1
- Spalling, 2-3-2-4, 4-1, 7-17
- Stemming, 7-1
- Stoppers, 4-8
- Straight:
 - gelatin, 3-13, 3-14, 3-15
 - nitroglycerin dynamite, 3-10, 3-11, 3-12
- Strengths of explosives, 3-1-3-12
- Subdrilling, 5-11-5-12
- Sulfur, 3-9, 3-12

- Tensile strength, 2-3, 2-4, 6-4
- Tensional wave, 2-3
- Tetranitro-diglycerin, 3-9
- Trapezoidal array, 5-4-5-5
- Trenching, 5-13
- Trinitrotoluene (TNT), 3-9, 3-20
- Trunk line, 3-23

- Unconfined velocity, 3-4
- Underwater blasting, 5-13-5-14

- Velocity seismograph, 7-11-7-12
- Vibratory drills, 4-8

- Wagon drill, 4-8, 4-11
- Water:
 - gels, 3-18
 - resistance, 3-1, 3-7
- Weathering coefficient, 6-15
- Weight strength, 3-1-3-4
- Wood pulp, 3-9

- Zinc oxide, 3-9